

Pre-treatments

2 Pre-treatment-foreword

3 Pre-treatments-foreword

4 Battery

5 Jacking points

7 Air-bag/Pre-tensioners

9 Fuel

10 Engine oil

11 Transmission oil

12 Coolant

13 Air conditioning refrigerant

14 Brake & clutch fluids

15 Damper oils

16 Washer fluid

17 Wheel and tyre

18 Catalysts

Pre-treatments

Pre-treatment-foreword

Lubricating oils

Avoid excessive skin contact with used lubricating oils and always adhere to the health protection precautions.

 Avoid excessive skin contact with used engine oil. Used engine oil contains potentially harmful contaminants which may cause skin cancer or other serious skin disorders.

 Avoid excessive skin contact with mineral oil. Mineral oils remove the natural fats from the skin, leading to dryness, irritation and dermatitis.

Health Protection Precautions

Avoid prolonged and repeated contact with oils, particularly used engine oils. Wear protective clothing, including impervious gloves where practicable. Do not put oily rags in pockets. Avoid contaminating clothes (particularly those next to the skin) with oil. Overalls must be cleaned regularly. Discard heavily soiled clothing and oil impregnated footwear. First aid treatment should be obtained immediately for open cuts and wounds.

Apply barrier creams before each work period, to help prevent lubricating oil from contaminating the skin. Wash with soap and water to ensure all oil is removed (skin cleansers and nail brushes will help). Use moisturisers after cleaning; preparations containing lanolin help replace the skin's natural oils which have been removed.

Do not use petrol/gasoline, kerosene, diesel fuel, oil, thinners or solvents for cleaning skin. If skin disorders develop, obtain medical advice without delay. Where practicable, degrease components prior to handling. Wear eye protection (e.g. goggles or face shield) if there is a risk of eye contamination. Eye wash facilities should be provided in close vicinity of the work area.



SKIN
IRRITANT



HARMFUL
CHEMICAL



FLAMMABLE



CORROSIVE



EXPLOSIVE

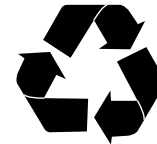

www.mg-uk.co.uk

Pre-treatments-foreword

Pre-treatment sections

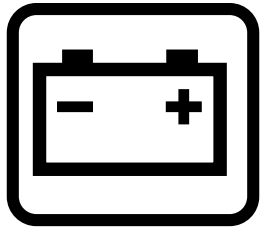

Battery



Air-bag



Fuel

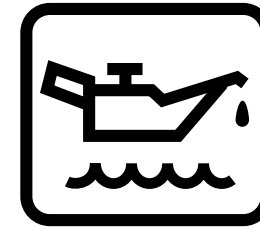

Engine oil

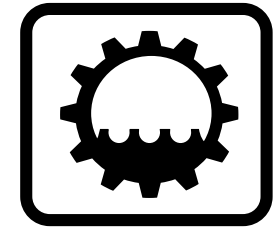

Trans oil

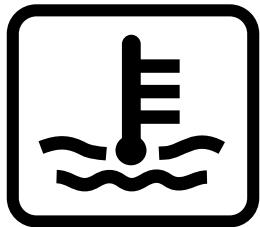

Coolant

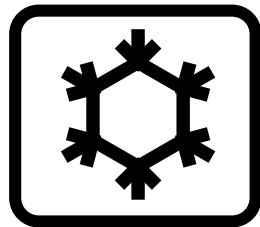

Air-Con



Brake fluid

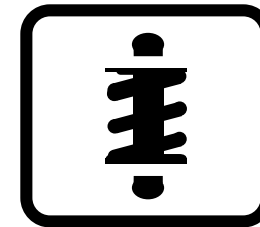

Damper oil

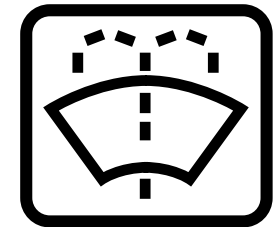

Screen wash

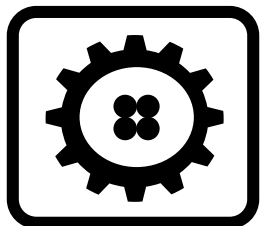

Wheel/Tyre

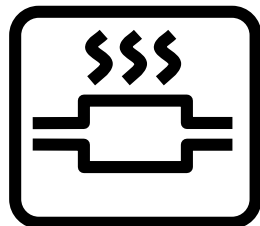

Catalyst



Haz/mats

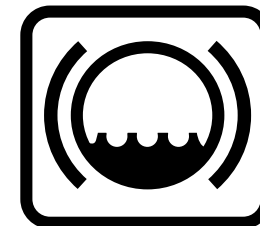

Steering oil



Many liquids and other substances used in motor vehicles are poisonous and should not be consumed under any circumstances. As far as possible, ensure such substances are prevented from contact with the skin. These liquids and substances include but are not limited to: acid, antifreeze, asbestos, brake fluid, fuel, windscreen washer additives, lubricants, refrigerant and various adhesives.



Always read the instructions printed on labels or stamped on components and obey them implicitly. Such instructions are included for reasons of your health and personal safety. Never disregard them.

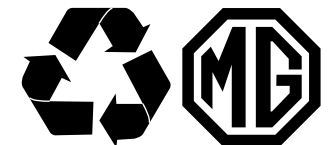

Pre-treatments

Battery

Pre-treatment-Battery removal

Part:	Battery
Weight:	14Kg
Care points:	Hazardous substance contains highly corrosive liquid. Do not contact with skin or eyes
Removal method:	Release battery cover. Remove bolt securing battery fixing strap with an M10 socket / ratchet and remove strap .
Recycling Notes:	Once removed the battery can be recycled via a battery recycling service provider.

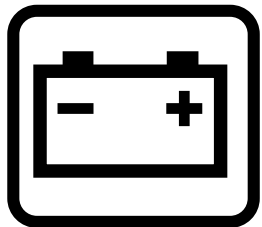
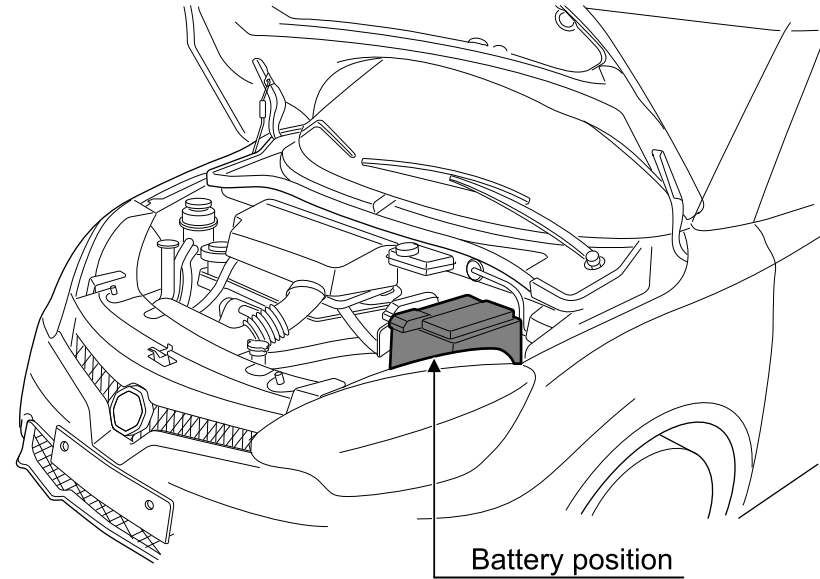

HARMFUL
CHEMICAL



FLAMMABLE



CORROSIVE



EXPLOSIVE

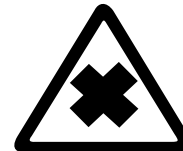

SKIN
IRRITANT

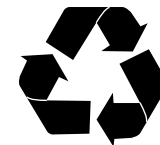

www.mg-uk.co.uk

Jacking points

Pre-treatment-Jacking points

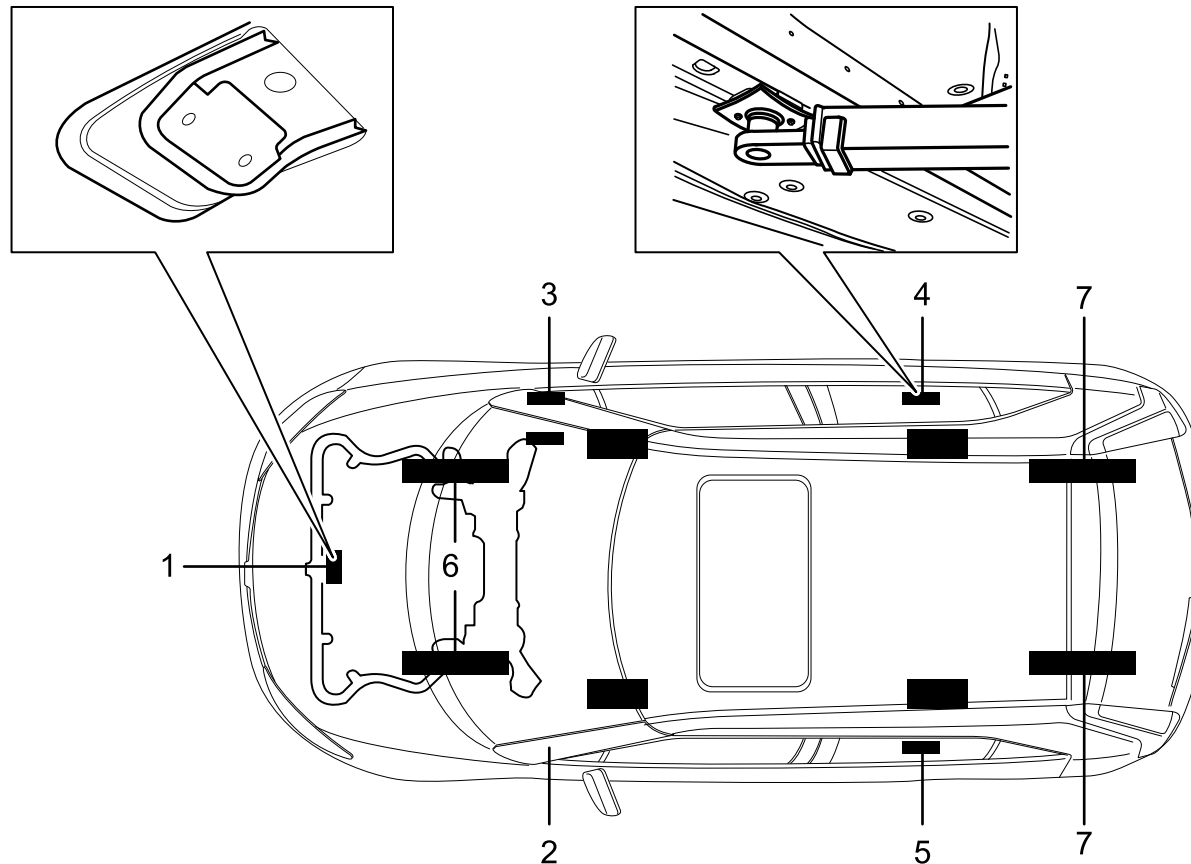

- 1 Central jacking point front
- 2 RH sill reinforced bracket front
- 3 LH sill reinforced bracket front
- 4 LH sill reinforced bracket rear
- 5 RH sill reinforced bracket rear
- 6 Subframe longitudinal member front
- 7 Subframe longitudinal member rear

If crossbeams are available locate the pads under the sill reinforced jacking brackets (2,3) and (4,5)

If longitudinal beams are available. Locate the beams under the subframe longitudinal with lifting pads at the front and rear positions (6&7) , raise the lift a few inches and ensure the vehicle is firmly supported. Raise the lift to full height and inspect the lifting points for security.

Pre-treatments

Pre-treatment-Undertray removal

Part:	Undertray
Weight:	
Care points:	
Removal method:	Raise the vehicle on a lift. Remove 10 screws securing undertray to vehicle and remove undertray.
Tooling:	Cross head screwdriver
Recycling Notes:	to be re ground

Note: Recycling of plastic material should only be conducted if a suitable waste stream is available and the part is economically viable to recycle. If waste streams are not in place these parts shall remain with the vehicle and be shredded all shredder residue shall be used for energy recovery purposes.

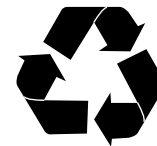

www.mg-uk.co.uk

Air-bag/Pre-tensioners

Pre-treatment – SRS deployment page 1

Part:	SRS (safety and restraints system)
Weight:	N/A
Care points:	Explosive; When airbags deploy they can cause serious injury. Take extreme care when deploying airbags. Skin irritant, take care when handling deployed air bags.
Removal method:	See notes
Tooling:	See notes
Recycling Notes:	N/A



SRS systems contain explosive devices, handle with care. Take extreme care when working with SRS systems. Unintentional deployment could lead to serious injury and death.



EXPLOSIVE

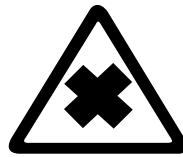

SKIN
IRRITANT

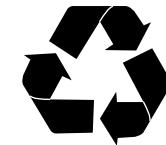

www.mg-uk.co.uk

Pre-treatments

Pre-treatment – SRS deployment continued page 2

These guidelines are written to aid authorised personnel to carry out the safe manual deployment and disposal of the SRS system.

If a vehicle is to be scrapped and contains an undeployed airbag module or pre-tensioner the components must be manually deployed. This operation should only be carried out using an approved deployment procedure and equipment.

 Always read and adhere to the SRS deployment precautions outlined in the equipment safety manual.

Always remove the key from the ignition switch and disconnect the vehicle battery (negative lead first) before starting the deployment procedures. Always observe the system safety instructions prior to use. Always wait for a period of 10 minutes (to allow the energy reserve capacitors to discharge) before disconnecting or removing any SRS components. Deploy the SRS system in a well ventilated, specially designated area. Ensure the seat belt pre-tensioner or airbag is not damaged or ruptured before deploying.

 Do not lean over the airbag module whilst connecting.

 Ensure all personnel are standing at least 15 metres (50 ft.) away Prior to deployment.

 A deployed airbag module/pre-tensioner will be very hot. DO NOT attempt to handle the module for 30 minutes after deployment.

 Wear a face shield and gloves when handling a deployed pre-tensioner unit or airbag. Wash hands and rinse well after handling a deployed pre-tensioner unit or airbag. *Skin irritant. DO NOT re-use, sell or salvage any parts of the seat belt, pretensioner or airbag Assemblies all parts should be shredded with the complete vehicle.



EXPLOSSIVE

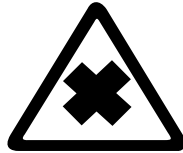

SKIN
IRRITANT

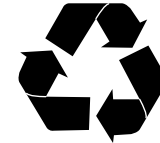

www.mg-uk.co.uk

Fuel

Pre-treatment-Fuel system

Part:	Petroleum
Weight:	Dependent on level
Care points:	Highly flammable take care with sources of ignition, ensure battery is removed or disconnected. Skin / eye irritant.
Removal method:	Fuel recovery device, follow manufacturers guidelines.
Tooling:	Fuel recovery device
Recycling Notes:	Once fuel is collected it can be returned to a fuel handling service for filtering and treatment.

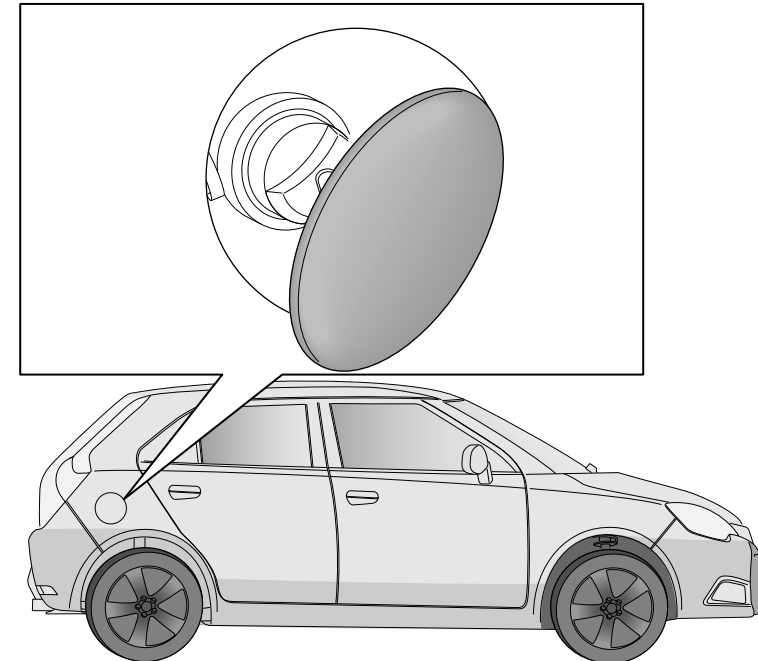

Petrol / gasoline vapour is highly flammable, and in contained spaces is also explosive and toxic. Always have a fire extinguisher containing FOAM, CO2 or Powder close at hand when handling or draining fuel



HARMFUL
CHEMICAL



FLAMMABLE

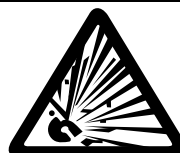

EXPLOSIVE

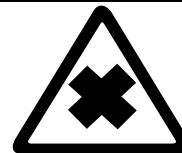

SKIN
IRRITANT

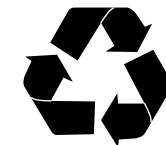

www.mg-uk.co.uk

Pre-treatments

Engine oil

Pre-treatment – Engine lubrication

Part:	Engine oil
Weight:	
Care points:	Skin irritant, repeated contact with used engine oil may cause serious skin disorders.
Removal method:	Remove sump plug and drain oil into suitable container.
Tooling:	Ratchet /M14 socket
Recycling Notes:	Drain oil into recycling tank Specialist service provider will recycle used oil

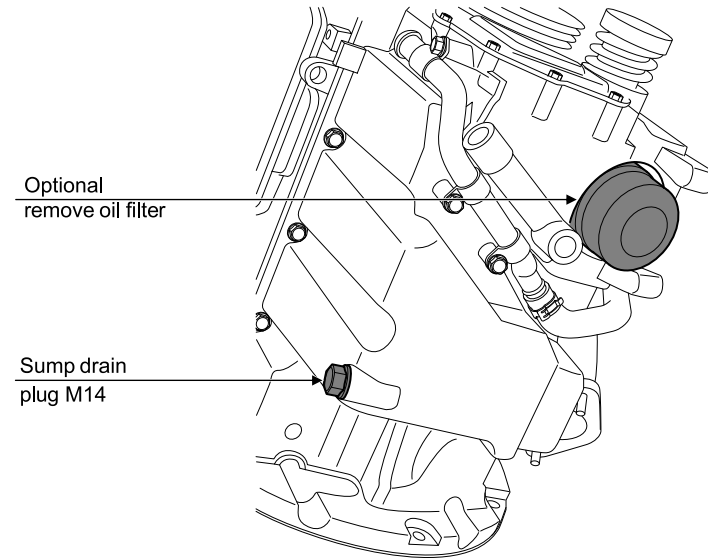

 Avoid excessive skin contact with used engine oil. Used engine oil contains potentially harmful contaminants which may cause skin cancer or other serious skin disorders. Avoid excessive skin contact with mineral oil. Mineral oils remove the natural fats from the skin, leading to dryness, irritation and dermatitis.



HARMFUL
CHEMICAL



FLAMMABLE



SKIN
IRRITANT

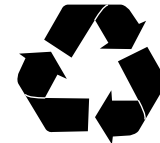

www.mg-uk.co.uk

Transmission oil

Pre-treatment – Transmission lubrication

Part:	Transmission oil
Weight:	
Care points:	Skin irritant, repeated contact with used transmission oil may cause serious skin disorders.
Removal method:	Remove drainage plug and drain oil into a suitable container.
Tooling:	Ratchet /M18 socket
Recycling Notes:	Drain oil into recycling tank Specialist service provider will recycle used oil

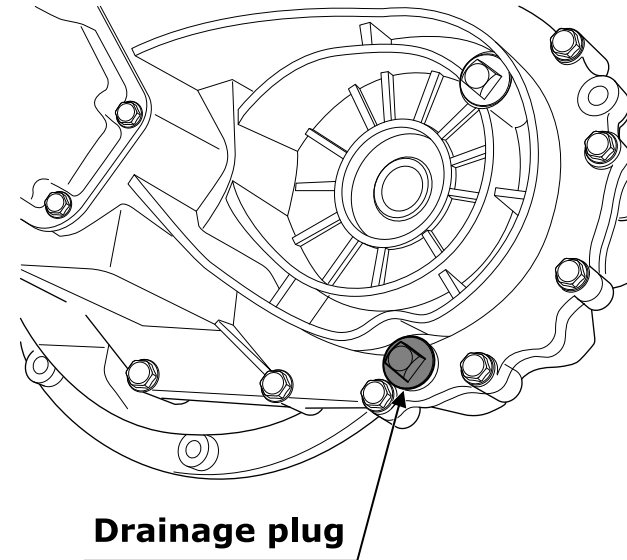

Avoid excessive skin contact with used transmission oil. Used transmission oil contains potentially harmful contaminants which may cause serious skin disorders. Avoid excessive skin contact with mineral oil. Mineral oils remove the natural fats from the skin, leading to dryness, irritation and dermatitis.

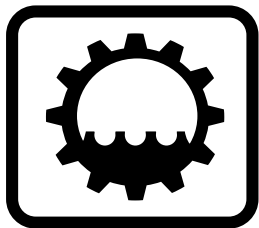

HARMFUL
CHEMICAL



FLAMMABLE



SKIN
IRRITANT

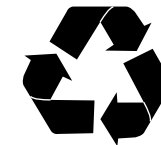

www.mg-uk.co.uk

Pre-treatments

Coolant

Pre-treatment – Engine coolant

Part:	Coolant
Weight:	
Care points:	Skin irritant.
Removal method:	Remove expansion tank cap, cut or remove underfloor coolant hoses while draining coolant into suitable container.
Tooling:	Stanley style knife or pliers.
Recycling Notes:	Drain coolant into recycling tank Specialist service provider will recycle used coolant.

Remove cap

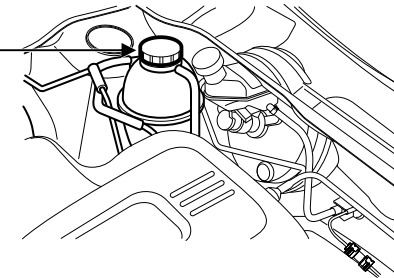

Cut Hoses

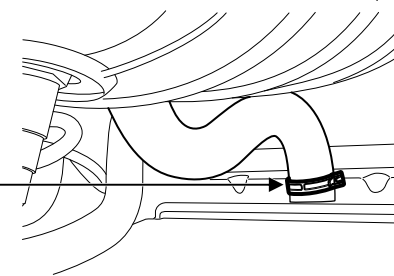

 Avoid excessive skin contact with used coolant. Used coolant contains potentially harmful contaminants which may cause skin irritation.



HARMFUL
CHEMICAL



SKIN
IRRITANT

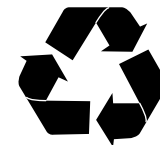

www.mg-uk.co.uk

Air conditioning refrigerant

Pre-treatment – Refrigerant

Part:	Air conditioning refrigerant
Weight:	
Care points:	Skin irritant.
Removal method:	Use Refrigerant recycling station
Tooling:	Refrigerant recycling station
Recycling Notes:	Refrigerant recycling service provider.



Refrigerant removal must only be carried out by personnel familiar with both the vehicle system and the charging and testing equipment. All operations must be carried out in a well ventilated area away from open flame and heat sources. Refrigerant must always be recycled before re-use to ensure that the purity of the refrigerant is high enough for safe use in the air conditioning system. Recycling should always be carried out with equipment which is design certified by Underwriter Laboratory Inc. for compliance with SAE J1991. Other equipment may not recycle refrigerant to the required level of purity.

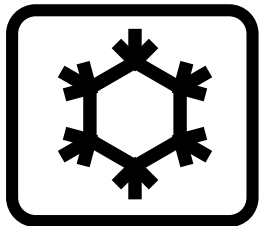

HARMFUL
CHEMICAL



SKIN
IRRITANT

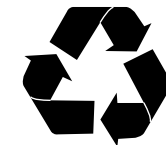

www.mg-uk.co.uk

Pre-treatments

Brake & clutch fluids

Pre-treatment-Brake/clutch fluid

- Part: Brake and clutch fluid
- Weight:
- Care points: Skin irritant
- Removal method: Remove caps from brake and clutch servo then cut brake pipes in position shown. Collecting all brake fluid within a suitable container.
- Tooling:
- Recycling Notes: Drain fluid into recycling tank Specialist service provider will recycle used brake/clutch fluid.

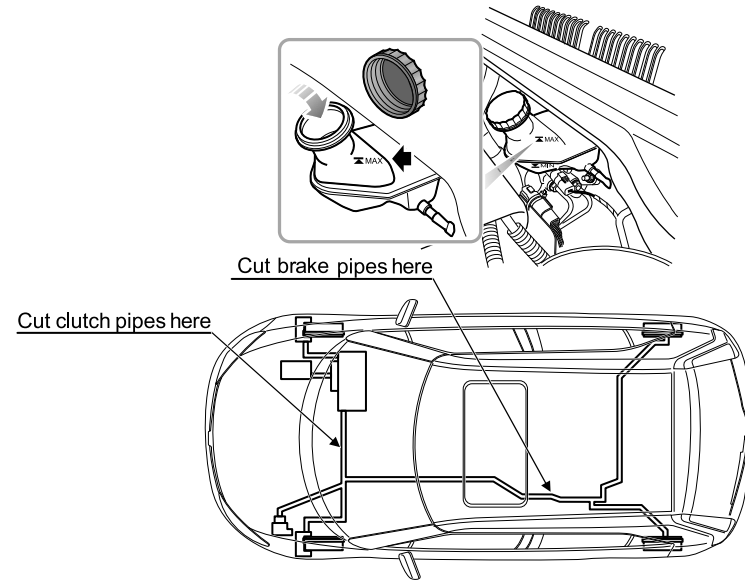

 Avoid excessive skin contact with used brake fluid. Used brake fluid contains potentially harmful chemicals which may cause skin irritation.



HARMFUL
CHEMICAL



FLAMMABLE



SKIN
IRRITANT

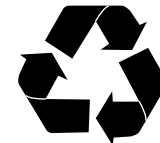

www.mg-uk.co.uk

Damper oils

Pre-treatment – Damper Oil

Part:	Damper oil
Weight:	
Care points:	Skin irritant
Removal method:	Use specialist equipment for damper oil retrieval. See manufacturers instructions.
Tooling:	Specialist damper oil retrieval equipment.
Recycling Notes:	One oil has been retrieved recycle using oil retrieval service.

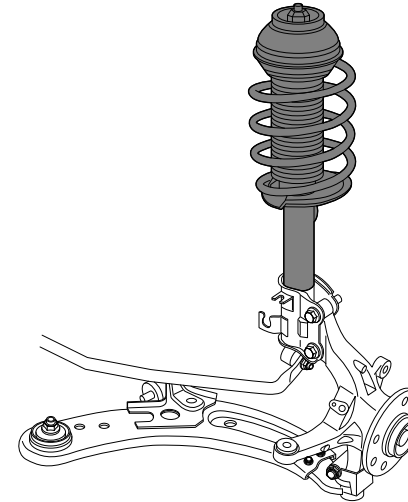

Avoid excessive skin contact with used damper oil. Used damper oil contains potentially harmful chemicals which may cause serious skin disorders.



Avoid excessive skin contact with mineral oil. Mineral oils remove the natural fats from the skin, leading to dryness, irritation and dermatitis.

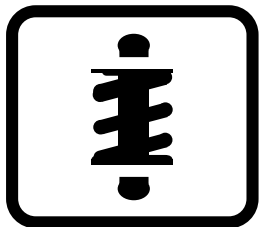

HARMFUL
CHEMICAL



FLAMMABLE



SKIN
IRRITANT

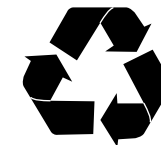

www.mg-uk.co.uk

Pre-treatments

Washer fluid

Pre-treatment – Screen wash

Part:	Screen wash
Weight:	
Care points:	Flammable, Skin irritant
Removal method:	Pierce washer bottle before removing the wheel arch liner and wheel.
Tooling:	Hammer / suitable spike
Recycling Notes:	Use external service provider to recycle collected fluids.

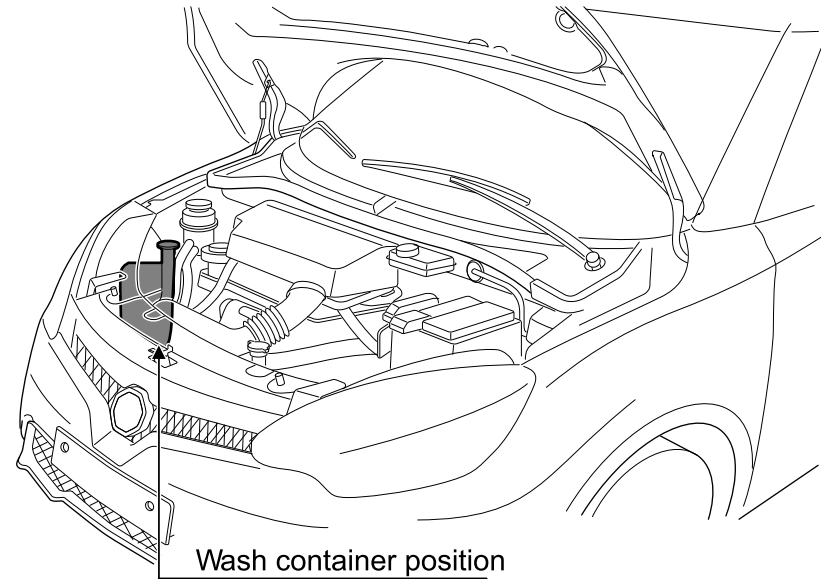

 Avoid excessive skin contact with Washer fluid. May cause skin irritation. Washer fluid contains alcohol which may cause blindness if ingested.

 Some screen wash products are flammable, particularly in high or undiluted concentrations. Keep screen wash away from naked flames.

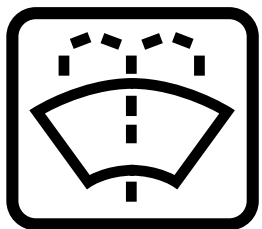

HARMFUL
CHEMICAL



FLAMMABLE



SKIN
IRRITANT

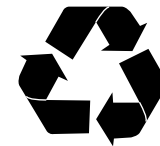

www.mg-uk.co.uk

Wheel and tyre

Pre-treatment – Wheel & Tyres

- Part: Wheel & Tyre assy
- Weight:
- Care points:
- Removal method: Using M17 socket remove the 5off studs. Use the locking wheel nut key to remove any wheels where a locking nut is present.
- Tooling: Wheel brace or air powered nut runner, locking wheel nut key.
- Recycling Notes: Alloy wheel – Aluminium smelting. Tyres – energy recovery
Tyres – energy recovery
About the spare wheel, steel wheel to be left in vehicle for shredding but the tyre removed.

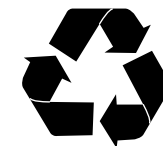
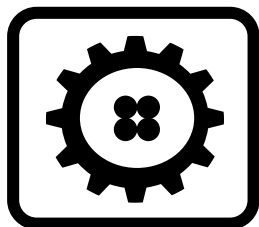
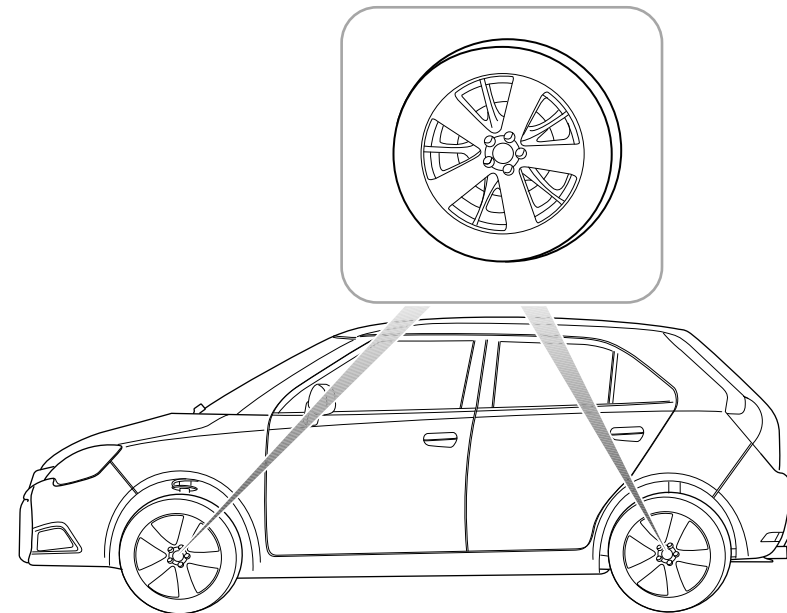

www.mg-uk.co.uk

Pre-treatments

Catalysts

Pre-treatment – Catalyst

Part: Catalyst

Weight:

Care points:

Removal method: Working from underneath the car, slide catalyst away from vehicle.

Tooling:

Recycling Notes: Specialist catalyst recycler

Ensure when recycling the catalyst suitable respiratory equipment is used.

Note: Catalyst contains heavy metals and refractory ceramic fibres which are harmful to human health. Ensure suitable health & safety precautions are taken when recycling the catalyst assy.

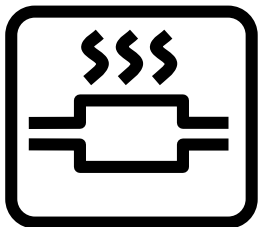
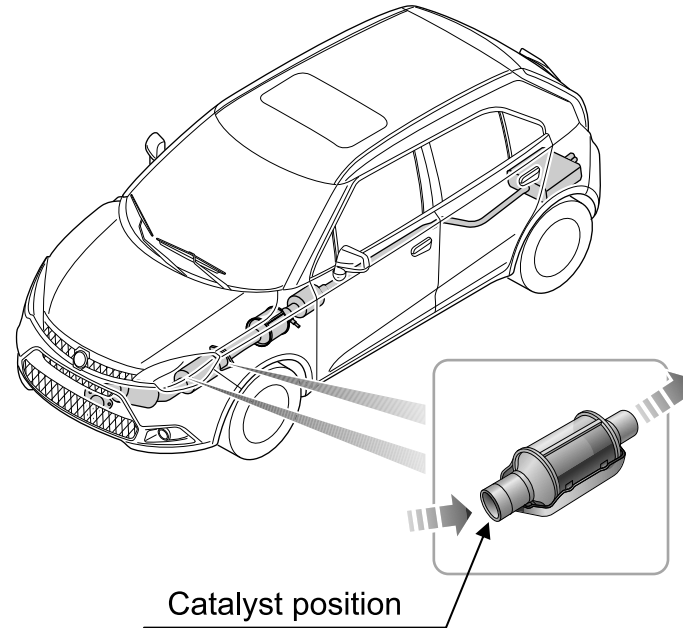

HARMFUL
CHEMICAL



SKIN
IRRITANT

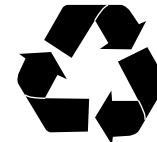

www.mg-uk.co.uk

Dismantling

20 Glazing systems

21 Bumpers/wheel arch liners

*23 Re-sale and re-use of
components*

Glazing systems

Dismantle– Glazing systems

Part:	Glazing
Weight:	
Care points:	
Removal method:	Cut front screen from vehicle Remove door casing, unscrew regulator fixings remove door glass.
Tooling:	socket / ratchet, flat blade screwdriver
Recycling Notes:	Smelt and re-use. Specific recycle service provider required

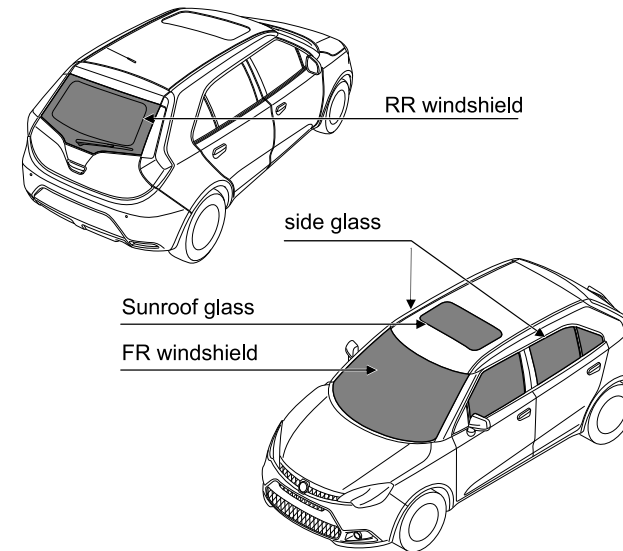

Note: Recycling of glass material should only be conducted if a suitable waste stream is available and the part is economically viable to recycle. If waste streams are not in place these parts shall remain with the vehicle and be shredded all shredder residue shall be used for energy recovery purposes.

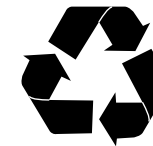

www.mg-uk.co.uk

Bumpers/wheel arch liners

Dismantle- Bumper systems

Part:	Front/rear bumper systems
Weight:	12Kg
Care points:	
Removal method:	Release 6 screws and 2 split pins
Tooling:	M10 socket and Cross head screwdriver
Recycling Notes:	PP/EPDM mix, to be re ground

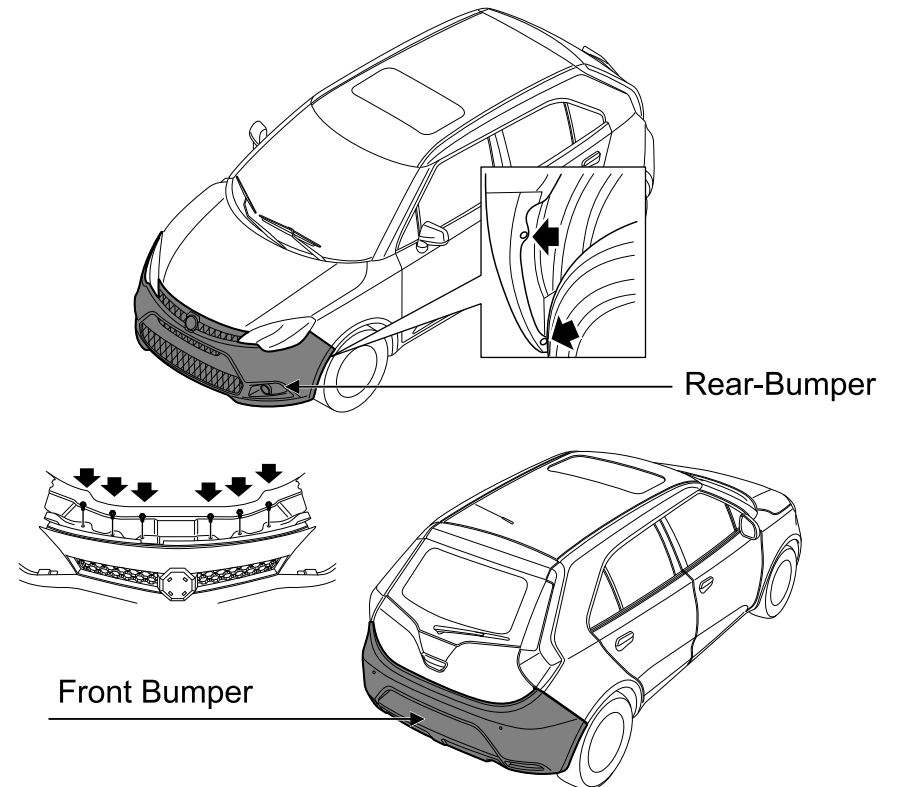

Note: Recycling of plastic material should only be conducted if a suitable waste stream is available and the part is economically viable to recycle. If waste streams are not in place these parts shall remain with the vehicle and be shredded all shredder residue shall be used for energy recovery purposes.

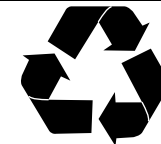

www.mg-uk.co.uk

Dismantle– Bumper systems

Part:	Wheel arch liners
Weight:	2Kg
Care points:	
Removal method:	Remove 7 screws and 2 spit pins securing wheel arch liner to body.
Tooling:	Cross head screwdriver
Recycling Notes:	PP/EPDM mix, To be re ground

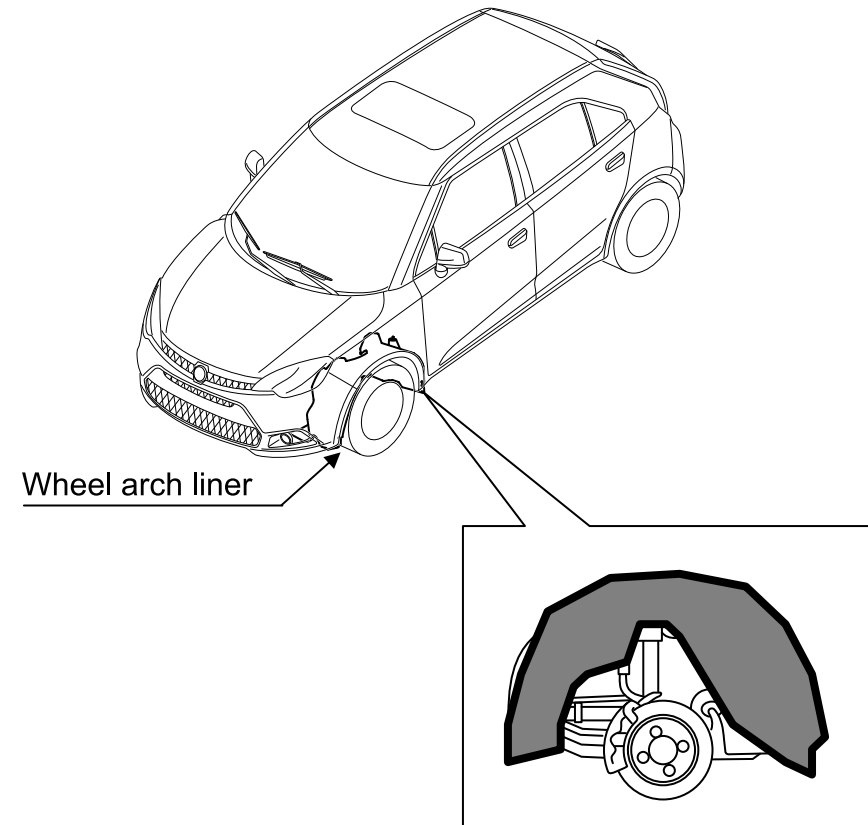

Note: Recycling of plastic material should only be conducted if a suitable waste stream is available and the part is economically viable to recycle. If waste streams are not in place these parts shall remain with the vehicle and be shredded all shredder residue shall be used for energy recovery purposes.

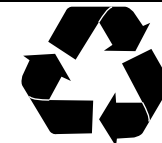

www.mg-uk.co.uk

Re-sale and re-use of components

Re-sale and Re-use of components

Under directive 2005/64/EC re-usability, recyclability and recoverability and amending directive 70/156/EEC the following parts are not permitted to be re-sold or re-used in the construction of a new vehicle.

- All airbags, including cushions, pyrotechnic actuators, electronic control units and sensors. (When the airbag is inserted in the steering wheel the steering wheel itself)
- Automatic or non automatic seat belt assemblies, including webbing, buckles, retractors, pyrotechnic actuators.
- Seats (only in cases where safety belt anchorages and/or airbags are incorporated in the seat.
- Steering lock assemblies acting on the steering column.
- Immobilisers, including transponders and electronic control units.
- Emission after-treatment systems (e.g. catalytic converters, particulate filters)
- Exhaust silencers.

If you wish to contact the SAIC Motor technical centre with regard to this vehicle pre-treatment and dismantling manual contact.

recycle@saicmotor.co.uk

Important Notice

MG Motor UK is constantly seeking to improve the specification, design and production of its vehicles and alterations take place continually. Whilst every effort is made to produce up to date literature, this UK dismantle brochure should not be regarded as a definitive guide. For further information with regard to this manual contact materials engineering SAICMotor technical Centre, Lowhill lane, Longbridge, Birmingham, B31 2TB

Note: MG-Motors do not recommend the re-sale or re-use of the listed components on used vehicles due to possible concerns on: Safety, Use for theft purposes and Environmental issues

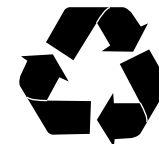

www.mg-uk.co.uk