

<b>Preface</b> .....	<b>1</b>
<b>Introduction</b> .....	<b>1</b>
The Owner's Handbook .....	1
Status at Time of Printing .....	1
Symbols Used .....	1
In an Emergency.....	2
<b>Vehicle Identification Information</b> .....	<b>3</b>
Vehicle Identification .....	3
Vehicle Identification Label .....	4
<b>I Instruments and Controls</b> .....	<b>7</b>
<b>Instruments and Controls</b> .....	<b>8</b>
<b>Instrument Pack</b> .....	<b>10</b>
Speedometer.....	10
Tachometer .....	10
Fuel Gauge.....	10
<b>Information Centre</b> .....	<b>12</b>
Digital Clock .....	12
Odometer.....	12

# CONTENTS

---

Next Service .....	12
Gear Display and Gear Shift Indication.....	13
Vehicle Information Display .....	13
<b>Warning Lights and Indicators.....</b>	<b>22</b>
<b>Lights and Switches.....</b>	<b>32</b>
Master Lighting Switch.....	32
Headlamp Levelling Manual Adjustment.....	34
Fog Lamp Switch .....	35
Direction Indicator/Main Beam Switch.....	36
Hazard Warning Lamp.....	37
<b>Wipers and Washers.....</b>	<b>38</b>
Windscreen Wiper Operation.....	38
Programmed Wash/Wipe .....	39
Rear Window Wiper Operation .....	40
<b>Steering System .....</b>	<b>42</b>
Adjustment of Steering Column.....	42
Electric Power Steering .....	43
<b>Horn.....</b>	<b>44</b>
<b>Mirrors .....</b>	<b>45</b>

Door Mirrors.....	45
Interior Rear-view Mirror .....	46
<b>Sunvisors.....</b>	<b>48</b>
<b>Windows.....</b>	<b>49</b>
Power Operated Window Switch .....	49
Window Operation.....	49
<b>Interior Lights.....</b>	<b>52</b>
<b>Front Power Socket.....</b>	<b>53</b>
<b>Storage Devices .....</b>	<b>54</b>
Instructions .....	54
Glove Box.....	54
Card Box.....	55
Loadspace .....	55
<b>Cup Holder.....</b>	<b>57</b>
Centre Console Cup Holder .....	57
<b>Roof Luggage Rack * .....</b>	<b>58</b>
Maximum Authorised Load for the Roof.....	58
Periodical Check.....	58

# CONTENTS

---

<b>2 Air Conditioning and Audio Systems .....</b>	<b>59</b>
<b>Ventilation .....</b>	<b>60</b>
Particle/Pollen Filter .....	61
Vents .....	61
<b>Manual Temperature Control * .....</b>	<b>63</b>
Control Panel.....	63
Temperature Control.....	63
Air Recirculation.....	63
Blower Motor Speed Control.....	63
Heated Rear Window .....	64
Air Distribution.....	64
<b>Electronic Temperature Control * .....</b>	<b>66</b>
Control Panel.....	66
System On/Off.....	67
Blower Motor Speed Control.....	67
Temperature Control.....	67
A/C On/Off .....	67
Air Distribution.....	67
Defrost/Demist .....	68

Heated Rear Window .....	68
Air Recirculation .....	69
<b>Radio *</b> .....	<b>70</b>
Instructions .....	70
Radio Control Panel.....	71
Basic Operations.....	72
Radio Function.....	73
USB Mode.....	75
Bluetooth Connection.....	76
Bluetooth Music .....	76
Bluetooth Phone .....	76
Bluetooth Function Menu .....	77
<b>Entertainment System *</b> .....	<b>78</b>
Important Safety Information.....	78
Warnings for Screen Use.....	79
Playable File Format for Entertainment System.....	80
Basic Operations.....	81
Bluetooth Phone .....	88
Entertainment.....	100

# CONTENTS

---

Apple CarPlay .....	109
Vehicle Settings .....	113
A/C Display * .....	115
Settings .....	116
<b>3 Seats &amp; Restraints .....</b>	<b>123</b>
<b>Seats .....</b>	<b>124</b>
Overview .....	124
Head Restraints .....	125
Manual Adjustment of Seats .....	126
Rear Seats .....	127
<b>Seat Belts .....</b>	<b>128</b>
Protection Provided by Seat Belts .....	129
Wearing Seat Belts .....	130
Seat Belt Pre-tensioners .....	134
Seat Belt Checks, Maintenance and Replacement .....	135
<b>Airbag Supplementary Restraint System .....</b>	<b>137</b>
Overview .....	137
Airbag Deployment .....	138
Conditions in Which Airbags Will Not Deploy .....	142

Disabling the Passenger Airbag.....	143
Service and Replacement of Airbags.....	144
Disposal of Airbags.....	145
<b>Child Restraints .....</b>	<b>146</b>
Important Safety Instructions about Using Child Restraints .....	146
Child Restraints Groups.....	149
Approved Child Restraint Positions .....	152
<b>4 Starting &amp; Driving .....</b>	<b>157</b>
<b>Keys.....</b>	<b>158</b>
Overview .....	158
Replacing Battery in Remote Key .....	159
<b>Child Proof Locks .....</b>	<b>162</b>
<b>Alarm System .....</b>	<b>163</b>
Engine Immobilisation .....	163
Electronic Anti-theft Alarm System.....	164
Tailgate.....	167
<b>Starting and Stopping Engine .....</b>	<b>169</b>
Ignition Switch .....	169

# CONTENTS

---

Starting the Engine.....	170
Precautions for Starting the Engine .....	171
Stopping the Engine.....	173
<b>Economical and Environmental Driving .....</b>	<b>174</b>
Running-in.....	174
Environment Protection.....	174
Driving Style.....	174
Fuel Saving and Extending Vehicle Life .....	175
Maintenance .....	177
<b>Catalytic Converter and Particulate Filter.....</b>	<b>178</b>
<b>Fuel System.....</b>	<b>180</b>
Fuel Requirements.....	180
Fuel Filler .....	181
Refueling.....	181
<b>Automatic Transmission * .....</b>	<b>182</b>
Instructions .....	182
Gear Shift.....	183
Vehicle Start-off.....	185
Control Mode.....	186



<b>Manual Transmission *</b> .....	<b>189</b>
5-speed Manual Transmission .....	189
<b>Brake System</b> .....	<b>191</b>
Foot Brake.....	191
Anti-lock Brake System (ABS) .....	194
Emergency Braking Hazard Warning Lights Control (HAZ).....	195
Active Rollover Protection (ARP).....	195
Parking Brake.....	196
<b>Automated Stop/Start —Intelligent Fuel Saving System *</b> .....	<b>197</b>
Automatic Shutdown of Engine .....	198
Engine Auto Stop Conditions .....	198
Stop/Start Prohibited .....	198
Automatic Engine Start .....	199
Start Inhibition.....	199
Stall Assist.....	200
Battery.....	200
Automated Stop/Start Intelligent Fuel Saving System Failure .....	201
Starter Inoperative, Serious Battery Capacity Loss .....	201
<b>Stability Control System (SCS) and Traction Control System (TCS)</b> .....	<b>202</b>

# CONTENTS

---

<b>Cruise Control System .....</b>	<b>203</b>
<b>Active Speed Limit (ASL) System.....</b>	<b>206</b>
Activate .....	206
Kick Down .....	207
Suspending ASL .....	207
Resuming ASL.....	207
Overshoot of Target Speed and Warning.....	208
<b>Parking Aid * .....</b>	<b>209</b>
Ultrasonic Sensor Parking Aid * .....	209
Parking Camera System * .....	211
<b>Tyre Pressure Monitoring System (TPMS).....</b>	<b>213</b>
<b>Load Carrying.....</b>	<b>215</b>
Loadspace Loading.....	215
Internal Loading.....	215
General Towing Safety.....	216
<b>5 Emergency Information .....</b>	<b>219</b>
<b>Hazard Warning Devices.....</b>	<b>220</b>
Hazard Warning Lights.....	220

Warning Triangle.....	220
<b>Emergency Starting .....</b>	<b>221</b>
Using Booster Cables .....	221
Starting the Car.....	221
<b>Vehicle Recovery.....</b>	<b>223</b>
Towing for Recovery.....	223
Transporter or Trailer with Rope.....	226
<b>Tyre Repair and Wheel Replacement .....</b>	<b>228</b>
Tool Identification.....	228
Tyre Repair .....	228
Spare Wheel and Tool Kit* .....	231
Changing a Wheel* .....	232
<b>Fuse Replacement .....</b>	<b>236</b>
Fuse.....	236
Fuse Box .....	237
Passenger Compartment Fuse Box .....	237
Engine Compartment Fuse Box .....	239
<b>Bulb Replacement .....</b>	<b>243</b>
Bulb Specification.....	243

# CONTENTS

---

Bulb Replacement.....	244
<b>6 Maintenance .....</b>	<b>255</b>
<b>Maintenance.....</b>	<b>256</b>
Routine Maintenance .....	256
<b>Bonnet .....</b>	<b>260</b>
Opening the Bonnet.....	260
Closing the Bonnet.....	260
Bonnet Open Warning.....	260
<b>Engine Compartment.....</b>	<b>262</b>
1.0L Turbocharged Engine Compartment.....	262
1.5L Engine Compartment.....	263
<b>Engine .....</b>	<b>264</b>
Engine Oil .....	264
Engine Oil Level Check and Refill .....	265
Engine Oil Specification .....	266
<b>Cooling System.....</b>	<b>267</b>
Coolant Check and Refill.....	267
Coolant Specification.....	267

<b>Brake</b> .....	<b>269</b>
Brake Pads .....	269
Brake Fluid Check and Top Up.....	269
Brake Fluid Specification .....	270
<b>Battery</b> .....	<b>271</b>
Battery Maintenance .....	271
Battery Replacement.....	271
<b>Washers</b> .....	<b>273</b>
Windscreen Washer Check and Top Up .....	273
Washer Nozzles.....	274
Washer Fluid Specification .....	274
<b>Wipers</b> .....	<b>275</b>
Wiper Blades .....	275
Replacing Front Wiper Blades .....	276
Replacing Rear Wiper Blades .....	277
<b>Tyres</b> .....	<b>278</b>
Overview .....	278
New Tyres .....	278
Directional Tyres.....	278

# CONTENTS

---

Tyre Life .....	278
Tyre Pressure .....	279
Driving Style.....	279
Wheel Balance.....	279
Wheel Alignment.....	279
Caring for Your Tyres .....	279
Tyre Pressure .....	280
Valves .....	280
Punctured Tyres .....	280
Tyre Wear Indicators .....	281
Replacement Tyres .....	281
Wheel Fitment Rotation .....	282
Snow Chains .....	282
<b>Cleaning and Vehicle Care.....</b>	<b>283</b>
External Car.....	283
Cleaning the Interior.....	286
<b>7 Technical Data .....</b>	<b>289</b>
<b>Technical Data Dimensions .....</b>	<b>290</b>
<b>Weights.....</b>	<b>291</b>

Towing Weights .....	291
Towing Bar Dimensions.....	292
<b>Major Parameters of Engine .....</b>	<b>294</b>
<b>Recommended Fluids and Capacities .....</b>	<b>296</b>
<b>Wheel Alignment (Unladen Condition) .....</b>	<b>298</b>
<b>Wheels and Tyres .....</b>	<b>298</b>
<b>Tyre Pressure (Cold) .....</b>	<b>299</b>
<b>8 Appendix .....</b>	<b>301</b>
<b>Removable Tow Bar .....</b>	<b>302</b>
Tow Bar Operating Instructions.....	302





## Introduction

### The Owner's Handbook

This handbook describes all of the vehicles and standard equipment specification within the model range. Some of the information therefore, may not apply to your particular car.

Always remember that if you have any queries concerning the operation or specification of your car, your MG Authorised Repairer will be glad to advise you.

### Status at Time of Printing

MG operates a policy of constant product improvement and therefore reserves the right to change specifications without notice at any time. Whilst every effort is made to ensure complete accuracy of the information in this publication, no liabilities for inaccuracies or the consequences thereof, including loss or damage to property, or injury to persons, can be accepted by the manufacturer or MG Authorised Repairer who supplied the publication, except in respect of personal injury caused by the negligence of the manufacturer or MG Authorised Repairer.

## Symbols Used

The following symbols used within the handbook call your attention to specific types of information.

### Warning



*This warning symbol identifies procedures that must be followed precisely, or information that must be considered with great care, in order to reduce the risk of personal injury or serious damage to the car.*

### Important

#### IMPORTANT

The statements stated here must be followed strictly, otherwise your car could be damaged.

### Note

*Note: This describes helpful information.*

# PREFACE

---



This symbol indicates that parts described must be disposed of by authorised persons or bodies to protect the environment.

## Asterisk

An asterisk (\*) appearing within the text, identifies features or items of equipment that are either optional, or are only fitted to some vehicles in the model range.

## Illustration Information



Identifies components being explained.



Identifies movement of components being explained.

All illustrations in this handbook are based on a RHD vehicle except where LHD model is stated.

## In an Emergency

### IMPORTANT

#### Remember the breakdown safety code

If a breakdown occurs while travelling:

- Wherever possible, consistent with road safety and traffic conditions, the car should be moved off the main thoroughfare, preferably into a lay-by. If a breakdown occurs on a motorway, pull well over to the inside of the hard shoulder.
- Switch on hazard lights.
- If available, position a warning triangle or a flashing amber light 50 to 150 metres (150 to 500 ft) behind your vehicle to warn approaching traffic. Note it is a legal requirement of some countries that a warning triangle is carried in the vehicle, if in doubt consult the local highways agency for further information.
- Consider evacuating passengers through nearside doors onto the verge to reduce risk of injury in the event of collision.

## Vehicle Identification Information

### Vehicle Identification

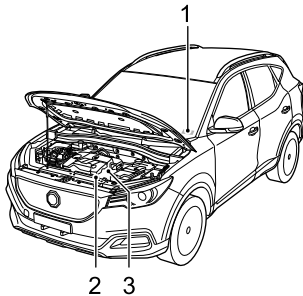

- 1 Vehicle Identification Number (VIN)
- 2 Engine Number
- 3 Transmission Number

Always quote the Vehicle Identification Number (VIN) when communicating with the MG Authorised Repairer. If your communication concerns the engine or transmission, it may be necessary to quote these numbers too.

### Vehicle Identification Location

#### *VIN Location*

- Stamped on a plate visible through the bottom left hand corner of the windscreen.
- On the vehicle identification plate.
- Stamped on the floor panel in the RHF footwell adjacent to the RHF seat.
- Stamped above the inner side of the tailgate visible by opening the tailgate.

**Note:** *The vehicle diagnostic socket is located under the RH side of the fascia panel. The VIN information can be accessed using the SAIC Diagnostic Scan Tool.*

#### *Engine Number Location*

Stamped on the front - right of the cylinder block. (View from the front end of the vehicle)

# PREFACE

---

## ***Transmission Number Location***

Stamped on the upper face of the transmission housing in the engine compartment. The transmission number of some vehicles is on the right transmission housing (viewed from the front end of the vehicle), which can be seen when the vehicle is lifted. Please contact an MG Authorised Repairer.

## **Vehicle Identification Label**

The vehicle identification label contains the following information.

- Type Approval Number
- Vehicle Identification Number (VIN)
- Gross Vehicle Weight
- Gross Tracking Weight
- Max Front Axle Weight
- Max Rear Axle Weight
- Paint Code
- Trim Code

## Location of Vehicle Identification Label

The identification label is located at the lower side of the right B pillar.

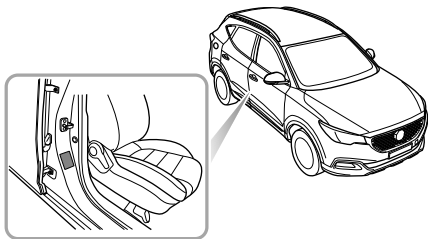



## ***Instruments and Controls***

---

- |    |                                      |    |                            |
|----|--------------------------------------|----|----------------------------|
| 8  | <i>Instruments and Controls</i>      | 54 | <i>Storage Devices</i>     |
| 10 | <i>Instrument Pack</i>               | 57 | <i>Cup Holder</i>          |
| 12 | <i>Information Centre</i>            | 58 | <i>Roof Luggage Rack *</i> |
| 22 | <i>Warning Lights and Indicators</i> |    |                            |
| 32 | <i>Lights and Switches</i>           |    |                            |
| 38 | <i>Wipers and Washers</i>            |    |                            |
| 42 | <i>Steering System</i>               |    |                            |
| 44 | <i>Horn</i>                          |    |                            |
| 45 | <i>Mirrors</i>                       |    |                            |
| 48 | <i>Sunvisors</i>                     |    |                            |
| 49 | <i>Windows</i>                       |    |                            |
| 52 | <i>Interior Lights</i>               |    |                            |
| 53 | <i>Front Power Socket</i>            |    |                            |

# INSTRUMENTS AND CONTROLS

---

## Instruments and Controls

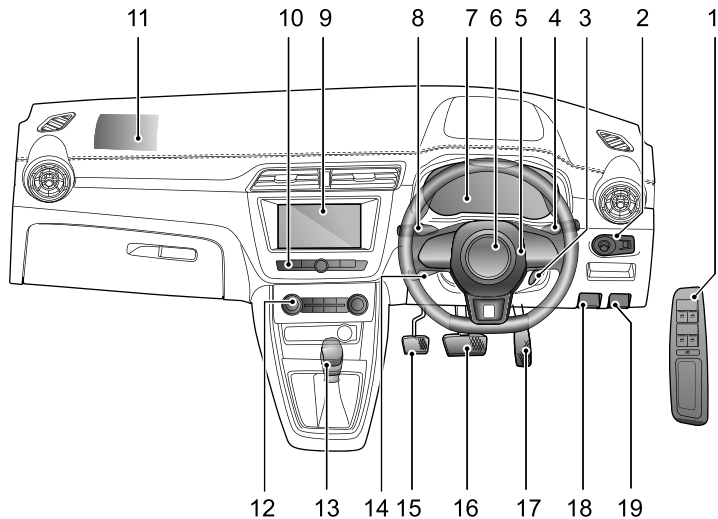



# INSTRUMENTS AND CONTROLS

---

- 1 Power Window Switch
- 2 Exterior Rearview Mirrors and Headlamp Levelling Adjustment Switch
- 3 Ignition Switch
- 4 Wiper/Washer Control
- 5 Horn Button
- 6 Driver Airbag
- 7 Instrument Pack
- 8 Indicator and Main Beam Stalk Switch
- 9 Onboard Entertainment System
- 10 Entertainment Controls \*
- 11 Front Passenger Airbag
- 12 Heating/Air Conditioning Controls
- 13 Gear Shift Lever
- 14 Cruise Stalk Switch
- 15 Clutch Pedal \*
- 16 Brake Pedal
- 17 Accelerator Pedal
- 18 Bonnet Release Handle
- 19 Fuel Filler Flap Release Handle

# INSTRUMENTS AND CONTROLS

## Instrument Pack

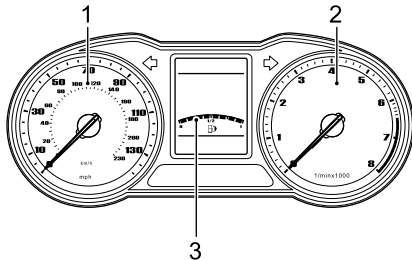

### Speedometer

Indicates the vehicle speed (1), in mph and km/h.

### Tachometer

Indicates the engine speed (2),  $\times 1000$  rpm.

### IMPORTANT

To protect the engine from damage, never allow the pointer to remain in the red sector of the gauge for prolonged periods.

### Fuel Gauge

The quantity of fuel in the tank is indicated by the number of segments illuminated. There are 8 segments in total (3). When only one segment illuminates, the low fuel warning lamp below the information centre will illuminate, accompanied by an audible warning. If the fuel continues to fall to a critical state, the leftmost segment and low fuel warning lamp will flash simultaneously, accompanied by an audible warning.

### IMPORTANT

If the low fuel warning lamp illuminates, refuel at the earliest opportunity.



The arrow to the right of the fuel gauge symbol in the display indicates that the fuel filler is located on the right of the vehicle.

# INSTRUMENTS AND CONTROLS

---

## Information Centre

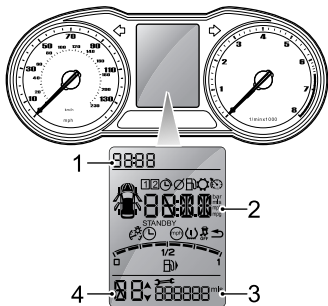

The information centre provides the following information:

- 1 Digital Clock
- 2 Vehicle Information Display
- 3 Odometer/Distance Until Next Service
- 4 Gear Display and Gear Shift Indication

## Digital Clock

Displays the current time in digital form.

## Odometer

With the ignition switch in the ON position, it displays total distance the car has travelled.

## Next Service

With the ignition switch in the ON position, the distance until next service will be shown for several seconds in the odometer display area of the information centre, this indicates the remaining distance until the next service, and then change to total mileage.

**Note:** *When the remaining distance is below 1000 miles the display will flash the remaining mileage before reverting to the odometer. To reset the next service indicator please contact an MG Authorised Repairer.*

## Gear Display and Gear Shift Indication

With the ignition switch in the ON position, it displays the current gear position of the transmission (P \*, R, N, D \*, 1, 2, 3, 4, 5, 6 \*, S \*). If "EP" is displayed, it indicates a fault with the automatic transmission. When the Up or Down arrow is displayed at the right side of the gear position, it indicates the driver to upshift or downshift when the conditions permit. Refer to "Manual Transmission" and "Automatic Transmission" in "Starting and Driving" section.



## Vehicle Information Display

The vehicle information display screen provides the followings:



- 1 Warning Information
- 2 Trip Computer Menu
- 3 Settings

### Warning Information

The vehicle information display uses the following icons to convey warning information to the driver.

Icon	Action
	Indicating to the driver to close all doors, bonnet and tailgate.
	Indicating to the driver that the selected speed has been exceeded.

# INSTRUMENTS AND CONTROLS

Icon	Action
	Indicating to the driver that ASL system is standby. If the activation conditions are not satisfied, the text "STANDBY" flashes.
	Indicating to the driver that ASL system is active. When the current vehicle speed exceeds the target speed, the ASL icon and target speed value will flash. Refer to "Active Speed Limit (ASL) System" in "Starting and Driving" section.
	Indicating to the driver that ASL system has a fault. Seek an MG Authorised Repairer for service.

## Trip Computer

With the ignition switch in the ON position, the trip computer functions can be selected as follows:

**Note: The trip computer display operation modes vary with model configuration.**

## Right Hand Steering Wheel Switches \*

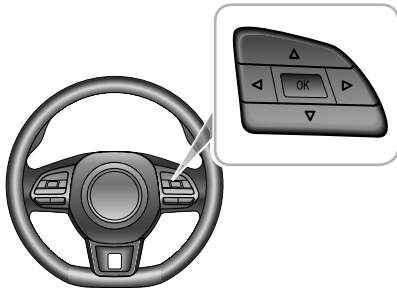

- Press the left/right buttons on the right of steering wheel to switch between the trip computer display items.
- Press OK button on the right of steering wheel to confirm or long press OK to reset.
- Press the up/down key on the right of steering wheel to make adjustment.

## Trip Computer Switch \*

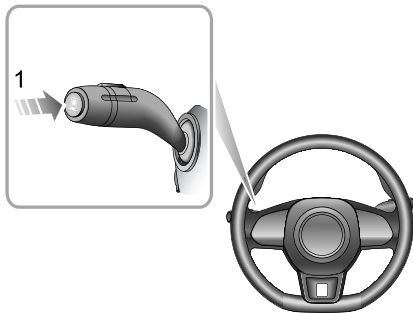

- Short press the trip computer button (1) on the end of the indicator/main beam switch to switch between the trip computer display items.
- Long press the trip computer button (1) on the end of the indicator/main beam switch to select or operate the trip computer display items.

The trip computer comprises the following information:

- 1 Trip 1
- 2 Journey Time 1
- 3 Average Speed 1
- 4 Average Fuel Consumption 1
- 5 Trip 2
- 6 Journey Time 2
- 7 Average Speed 2
- 8 Average Fuel Consumption 2
- 9 Fuel Range to Empty
- 10 Instantaneous Fuel Consumption

### Trip 1



# INSTRUMENTS AND CONTROLS

---

Displays the driven distance of the current journey or since last reset. This value will be automatically reset 1 hour after the ignition is switched off and can also be reset by a long press of the OK button in the right hand steering wheel switch or trip computer button.

**Note:** *Reset any item of Trip 1, Journey Time 1, Average Speed 1, Average Fuel Consumption 1, and other items will also be reset.*

## Journey Time 1



Displays the driving time of the current journey or since last reset. This value will be automatically reset 1 hour after the ignition is switched off and can also be reset by a long press of the OK button in the right hand steering wheel switch or trip computer button.

## Average Speed 1



Displays the average speed from the current journey or since last reset. This value will be automatically reset 1 hour after the ignition is switched off and can also be reset by a long press of the OK button in the right hand steering wheel switch or trip computer button.

## Average Fuel Consumption 1





Displays the average fuel consumption of the current journey or since last reset. This value will be automatically reset 1 hour after the ignition is switched off and can also be reset by a long press of the OK button in the right hand steering wheel switch or trip computer button.

**Note: The fuel consumption is related to driving style, road condition, load, tyre pressure, vehicle electrical appliance application and maintenance levels etc.**

## **Trip 2**

Displays the driven distance since the last reset. This value can be reset by a long press of the OK button in the right hand steering wheel switch or trip computer button.

## **Journey Time 2**

Displays the journey time since last reset. This value can be reset by a long press of the OK button in the right hand steering wheel switch or trip computer button.

## **Average Speed 2**

Displays the average speed since last reset. This value can be reset by a long press of the OK button in the right hand steering wheel switch or trip computer button.

## **Average Fuel Consumption 2**

Displays the average fuel consumption since last reset. This value can be reset by a long press of the OK button in the right hand steering wheel switch or trip computer button.

**Note: The fuel consumption is related to driving style, road conditions, load, tyre pressure, vehicle electrical appliance application and maintenance levels etc.**

## **Fuel Range to Empty**



# INSTRUMENTS AND CONTROLS

---

This function is automatic and displays the remaining distance you can travel before the fuel gauge reads empty. The distance will change when the vehicle is refuelled.

Fuel Range to Empty is calculated based on the combination of current fuel consumption and the remaining fuel in the tank.

## *Instantaneous Fuel Consumption*

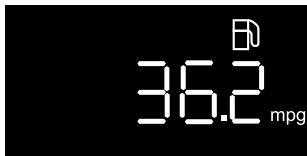

Displays the current fuel consumption when the vehicle is driven. When the vehicle is stationary or the vehicle speed is very low, the instantaneous fuel consumption will be displayed as "–.–mpg". In other conditions, the instantaneous fuel consumption will be calculated and displayed normally.

## **Settings**

In the trip computer interface, press the left/right button on the right hand steering wheel switch or short press the trip computer switch on the indicator/main beam switch to access the trip computer settings interface.



To enter the Settings interface press the OK button of the right hand steering wheel switch or long press the trip computer switch on the indicator/main beam switch.

The following setting options are provided:

- Backlight Brightness Adjustment
- Digital Clock Adjustment \*
- Speed Limit Alarm Adjustment
- Tyre Pressure Monitoring
- Stability/Traction Control System Off Switch

- Exit

## Backlight Brightness Adjustment



In this interface, press OK key on the right hand steering wheel switch or long press the trip computer button on the indicator/main beam switch to adjust the backlight brightness. The backlight brightness level can be adjusted by pressing the up/down button on the right hand steering wheel switch or short pressing the trip computer button on the indicator/main beam switch. There are 3 brightness levels in total.

**Note:** This option will only be accessible when the sidetail lamps are on.

## Digital Clock Adjustment \*

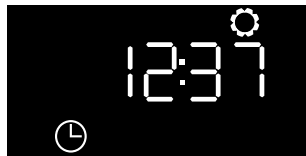

In this interface, press OK key on the right hand steering wheel switch or long press the trip computer button, the hour display value will flash; press the left/right key on the right hand steering wheel switch or long press the trip computer button, the minute display value will flash; the values can be adjusted by pressing the up/down key on the right hand steering wheel switch or short pressing the trip computer button. The setting range of hour display value is 0 ~ 23, and that of minute display value is 0 ~ 59; after completion, press OK key on the right hand steering wheel switch or long press the trip computer button to confirm, the time will be displayed in the digital clock display area of information centre.

# INSTRUMENTS AND CONTROLS

---

## Speed Limit Alarm Adjustment

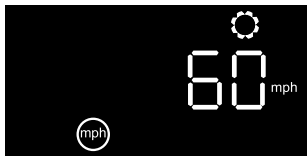

In this interface, press OK key on the right hand steering wheel switch or long press the trip computer button on the indicator/main beam switch. The current selected speed limit will be displayed and flash, this limit can be adjusted up or down using the up/down buttons on the right hand steering wheel switch or the trip computer button, the range is 20 - 140 mph. If "OFF" is displayed, the speed limit alarm function is disabled. If the vehicle speed exceeds the preset speed, the set speed value will flash, accompanied with audible warning.

## Tyre Pressure Monitoring



In this interface, press OK key on the right hand steering wheel switch or long press the trip computer button on the indicator/main beam switch to display the tyre pressure of each individual wheel. Use the left/right buttons on the steering wheel switch or short press the trip computer button to cycle through the wheels.

## Stability/Traction Control System Off Switch



In this interface, short press OK button on the right hand steering wheel switch or long press the trip computer button on the indicator/main beam switch to turn the stability control system and traction control system On/Off. When the systems are off, the system Off warning lamp will illuminate.

**Note:** *This option will only be accessible when the engine is running.*

## Exit

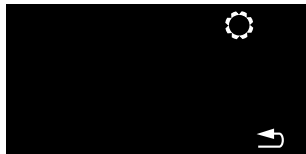

In this interface, press OK key on the right hand steering wheel switch or long press the trip computer button on the indicator/main beam switch to exit.

# INSTRUMENTS AND CONTROLS

---

## Warning Lights and Indicators

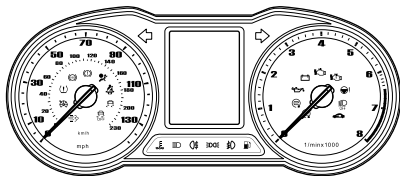

Warning and indicator lamps are located in the speedometer, tachometer and below the information centre.

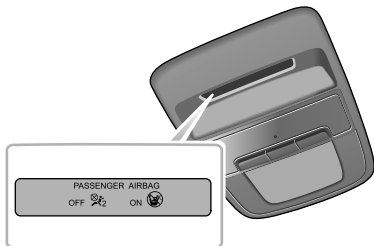

Front passenger airbag ON/OFF indicator lamps are located on the auxiliary display module, located on the front interior lamp and reading lamp.

## Main Beam Indicator - Blue



The indicator illuminates when the headlamp main beam is turned on.

## Dipped Beam Off - Yellow



With the ignition switch in the ON position, this lamp illuminates to conduct a system self-check and extinguishes upon the completion. If this lamp does not extinguish or illuminates during driving, it indicates to the driver that the dipped beam lamps are switched off and that it is necessary to turn them on. The indicator flashes first and then remains on or until the driver switches the dipped beam lamps on.

## Side Lamp Indicator - Green



The indicator illuminates when the side lamps are turned on.

If the driver's door is opened when the side lamps are switched on, an audible warning will be sounded to remind the driver to switch the lamps off.

## Rear Fog Lamp Indicator - Yellow



The indicator illuminates when the rear fog lamps are turned on.

## Front Fog Lamp Indicator - Green \*



The indicator illuminates when the front fog lamps are turned on.

## Direction Indicators - Green



The left and right direction indicator lamps are represented by directional arrows that are located at the top of the instrument pack. When the turning signal lamp flashes, the direction indicator lamp on the corresponding side also flashes. If the hazard warning

# INSTRUMENTS AND CONTROLS

---

lamps are operated, both direction indicator lamps will flash together. If either direction indicator lamp in the instrument flashes very rapidly, it indicates the turning signal lamp on the corresponding side has failed.

**Note:** *Failure of a side repeater lamp will have no effect on the flash frequency of direction indicator.*

## Airbag Warning Lamp - Red



With the ignition switch in the ON position, this lamp illuminates to conduct a system self-check and extinguishes upon the completion. If this lamp does not extinguish or illuminates during driving, it indicates that there is a failure in the SRS or seat belt. Please seek an MG Authorised Repairer at the earliest opportunity. An SRS or seat belt fault may mean the components may not be deployed in the event of an accident.

## Seat Belt Unfastened Warning Lamp - Red



With the ignition switch in the ON position, this lamp illuminates to conduct a system self-check and extinguishes upon the completion. If this lamp does not extinguish, it indicates that the seat belt for the driver or front passenger remains unfastened.

When the vehicle speed exceeds 14 mph (22 km/h) and a seat belt for driver or front passenger remains unfastened, this lamp flashes, accompanied by an audible warning, then remains on or extinguish when the seat belt is fastened.

## Cruise Control Indicator - Green/Yellow



If the cruise is switched on, the cruise control system will enter the standby state, and the indicator illuminates in yellow.

When the cruise control system operates, the indicator illuminates in green, which indicates the cruise control system is activated.



If a cruise control system failure has been detected, the indicator will flash in yellow, accompanied by an audible warning. Please seek an MG Authorised Repairer at the earliest opportunity.

## Low Oil Pressure Warning Lamp - Red



With the ignition switch in the ON position, the lamp illuminates to conduct a system self-check and extinguishes after the vehicle is started. If the lamp remains ON after starting the vehicle or illuminates during driving, it indicates that the oil pressure is very low, which may result in severe engine damage. Stop the vehicle as soon as safety permits and switch off the engine immediately. Check the oil level. Seek an MG Authorised Repairer at the earliest opportunity.

## Alternator Malfunction Indicator Lamp - Red



With the ignition switch in the ON position, the lamp illuminates to conduct a system self-check and extinguishes after the vehicle is started. If the lamp remains

ON after starting the vehicle or illuminates during driving, please seek an MG Authorised Repairer at the earliest opportunity.

If the battery power is low, this lamp will flash, accompanied by an audible warning, please run the engine in order to charge the battery.

## Tyre Pressure Monitoring System (TPMS) Warning Lamp - Yellow



With the ignition switch in the ON position, this lamp illuminates to conduct a system self-check and extinguishes upon the completion. If this lamp does not extinguish or illuminates during driving, it indicates the tyre pressure is low, please check the tyre pressure.

If this lamp flashes first and then remains on after a period of time, it indicates the system has a failure, please seek an MG Authorised Repairer at the earliest opportunity.

# INSTRUMENTS AND CONTROLS

---

## Stability Control System/Traction Control Warning Lamp - Yellow



With the ignition switch in the ON position, this lamp illuminates to conduct a system self-check and extinguishes upon the completion. If this lamp does not extinguish or illuminates during driving, it indicates the system has a failure. Please seek an MG Authorised Repairer at the earliest opportunity.

If this lamp flashes during driving, it indicates the system is operating to assist the driver.

## Stability Control System/Traction Control OFF Warning Lamp - Yellow



If the dynamic stability control/traction control system is switched off manually, this warning lamp will illuminate.

## ABS Malfunction Indicator Lamp - Yellow



With the ignition switch in the ON position, this lamp illuminates to conduct a system self-check and extinguishes upon the completion. If the lamp does not extinguish, seek an MG Authorised Repairer at the earliest opportunity.

If an ABS failure occurs while driving, ABS operation will be suspended, but normal braking will still be available. Please seek an MG Authorised Repairer at the earliest opportunity.

## Brake System Malfunction Indicator Lamp - Red



With the ignition switch in the ON position, this lamp illuminates to conduct a system self-check and extinguishes upon the completion. If this lamp does not extinguish or illuminates during driving, it indicates a failure with the braking system such as brake fluid loss, electronic brake force distribution failure or parking brake not released.

The lamp illuminates when the parking brake is applied and extinguishes when it is fully released. If the parking brake is not released, when the vehicle speed exceeds 3 mph (5 km/h), this warning lamp will flash, accompanied by an audible warning.

If the lamp remains on after the parking brake has been released, it indicates that there is a failure in the braking system. Please seek an MG Authorised Repairer at the earliest opportunity. Check brake fluid level (refer to "Brake Fluid Check and Refill" under the "Service and Maintenance" section). If the lamp remains on, stop the car as soon as safety permits and seek an MG Authorised Repairer at the earliest opportunity.

## Engine Malfunction Indicator Lamp - Yellow



The indicator lamp is used to indicate any failure detected by the engine management system which seriously affects the engine performance. With the ignition switch in the ON position, this lamp illuminates to conduct a system self-check and extinguishes upon the completion.

This lamp will illuminate if a failure that may affect the engine performance occurs during driving. Please seek an MG Authorised Repairer at the earliest opportunity.

## Engine Emission Malfunction Indicator Lamp - Yellow



The indicator lamp is used to indicate any engine condition that will effect engine performance or emissions. With the ignition switch in the ON position, the lamp illuminates to conduct a system self-check and extinguishes after the car is started.

If the failure affecting the engine performance and emission occurs during driving, it will illuminate. Please seek an MG Authorised Repairer at the earliest opportunity.

## Engine Coolant Temperature Warning Lamp - Red/Blue



When the engine coolant temperature warning lamp illuminates blue, it indicates the engine coolant

# INSTRUMENTS AND CONTROLS

---

temperature is low. This lamp will extinguish after driving normally for a period of time.

When the engine coolant temperature warning lamp illuminates red, it indicates that the engine coolant temperature is too high.

If the engine coolant temperature continues to rise, the engine coolant temperature warning lamp will flash, accompanied by an audible warning. High engine coolant temperature may cause severe damage to the engine. In this case, stop the vehicle and switch off the engine as soon as safety permits. Please seek an MG Authorised Repairer at the earliest opportunity.

When the engine coolant temperature warning lamp illuminates blue and flashes, it indicates that the instrument pack is not receiving the engine coolant temperature signal. Please seek an MG Authorised Repairer at the earliest opportunity.

## Electric Power Steering (EPS) - Red/Yellow



With the ignition switch in the ON position, this lamp illuminates red first, then changes into yellow, and extinguishes after a system self-check.

When the electric power steering system has a general failure its performance is reduced, this lamp illuminates yellow, accompanied by an audible warning. Please seek an MG Authorised Repairer at the earliest opportunity.

When the electric power steering system has a failure related to the steering angle sensor its performance is reduced, this lamp illuminates red accompanied by an audible warning, at this time other systems could be effected. Please seek an MG Authorised Repairer at the earliest opportunity.

When the electric power steering system has a severe failure, this lamp illuminates red and flashes, accompanied by an audible warning. Please seek an MG Authorised Repairer at the earliest opportunity. In this condition the electric power steering system does not provide

assistance. It is still possible to steer and control the car but the effort required to operate the steering is greater.

## Immobiliser System Warning Lamp - Red



With the ignition switch in the ON position, this lamp illuminates to conduct a system self-check and extinguishes upon the completion.

With the ignition switch in the ON position, if no valid key is detected, this lamp illuminates red, please use the correct key.

With the ignition switch in the ON position, if the remote key battery power is low, this lamp flashes, please replace the key battery as soon as possible.

## Automated Stop/Start - Intelligent Fuel Saving System Status Indicator — Green \*



With the ignition switch in the ON position, this lamp illuminates to conduct a system self-check and extinguishes upon the completion. If the automated

Stop/Start - intelligent fuel saving system is activated, this lamp illuminates to inform the driver that the engine is controlled by the system. When the automated Stop/Start – intelligent fuel saving system is currently unavailable, this lamp flashes three times and then extinguishes.

## Automated Stop/Start - Intelligent Fuel Saving System Malfunction Warning Lamp — Yellow \*



With the ignition switch in the ON position, this lamp illuminates to conduct a system self-check, and extinguishes upon the completion. If this lamp does not extinguish or illuminates during driving, it indicates that the system has a failure. Please seek an MG Authorised Repairer at the earliest opportunity.

## Low Fuel Warning Lamp - Yellow



When the remaining fuel in the fuel tank is low, this warning lamp illuminates, accompanied by an audible

# INSTRUMENTS AND CONTROLS

---

warning. If possible, please refuel before the low fuel warning lamp illuminates.

When the fuel level continues to fall, this lamp flashes accompanied by the audible warning. When fuel in the tank exceeds the alert line, this lamp extinguishes. If it does not extinguish, seek an MG Authorised Repairer at the earliest opportunity.

**Note:** *When driving on steep or rough roads while the fuel level is low, the warning lamp may illuminate.*

## Particulate Filter Warning Lamp - Red/Yellow \*



With the ignition switch in the ON position, this lamp illuminates to conduct a system self-check and extinguishes upon the completion.

When this lamp illuminates yellow, it indicates that the particulate filter requires regeneration. Please drive the vehicle at speeds above 40 mph until the light is no longer illuminated, and then normal usage can be resumed.

When this lamp illuminates red, it indicates that the particulate filter is full, the engine malfunction indicator

lamp illuminates at the same time. Please seek an MG Authorised Repairer at the earliest opportunity. Please note if the warning is ignored, the vehicle will enter a reduced performance mode and may subsequently be immobilised.

Please refer to “Catalytic Converter and Particulate Filter” in “Starting & Driving” section.

## Front Passenger Airbag Off Indicator - Yellow



The indicator is located in the auxiliary display module, and used to indicate the front passenger airbag is disabled. If the front passenger airbag is disabled, this indicator will remain on until the airbag is enabled. After the front passenger airbag is enabled, this indicator will extinguish.

## Front Passenger Airbag On Indicator - Yellow



The indicator is located in the auxiliary display module, and used to indicate the front passenger airbag

is enabled. If the front passenger airbag is enabled, this indicator will remain on until the airbag is disabled. After the front passenger airbag is disabled, this indicator will extinguish.

# INSTRUMENTS AND CONTROLS

## Lights and Switches

### Master Lighting Switch

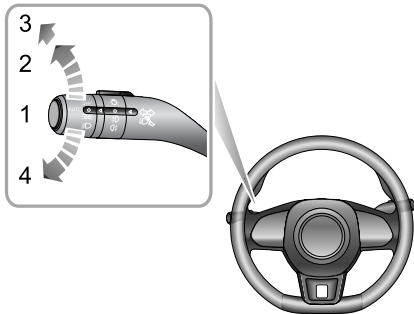

- 1 AUTO Lamp
- 2 Side/Tail Lamps and Switch Illumination
- 3 Dipped Headlamps
- 4 Lights OFF

### AUTO Lamp

When the ignition is in the ACC position, the auto lighting system is defaulted to the ON position (1). The auto lighting system will automatically switch the side/tail lamps and switch illumination on and off according to the intensity of current ambient light.

With the ignition switched to ON position, the auto lighting system is defaulted to the ON position (1). The auto lighting system will automatically switch the side/tail lamps, switch illumination and dipped headlamps on and off according to the intensity of current ambient light.

**Note:** *This function is realized by fitting a sensor capable of monitoring exterior lighting conditions in real time on your vehicle. The sensor is fitted in the centre of the fascia panel near the windscreen. DO NOT mask or cover this area, or headlamps may automatically go on when not necessary.*

### Side/Tail Lamps and Switch Illumination

Turn the master lighting switch to position 2 to operate the side/tail lamps and switch illumination. With the ignition



switch in the OFF position if the lighting switch is in position 2 and the driver's door opened an audible warning will sound to alert the driver, the side/tail lamps will remain on.

## **Dipped Headlamps**

When the ignition switch is in the ON position, turn the master lighting switch to position 3 to operate the dipped headlamps and side/tail lamps.

## **Lights Off**

Turn the master lighting switch to position 4, this will switch off all lamps, releasing the switch will allow it to return to the AUTO switch position.

## **Follow Me Home**

After the ignition switch is turned off, pull the lighting stalk switch towards the steering wheel. This will enable the Follow Me Home function, dipped beam headlamps and rear fog lamps will illuminate depending upon the vehicle configuration. For some models, it can be set in

the "Comfort and Convenience" in "Vehicle" settings on the entertainment display.

## **Daytime Running Lamp**

The daytime running lamps turn on automatically when the ignition switch is in the ON position. When the side lamps are switched on, the daytime running lamps extinguish automatically.

## **Find My Car**

After the vehicle has been left in a locked condition for 2 minutes pressing the lock button again on the remote key will enable the Find My Car function. This function will identify the car by means of an audible and visual alert. Pressing the Lock button on the handset again will suspend this operation. Pressing the Unlock button will cancel this operation. On some models this feature can be set via "Comfort and Convenience" in the Vehicle Settings on the entertainment display.

# INSTRUMENTS AND CONTROLS

## Headlamp Levelling Manual Adjustment

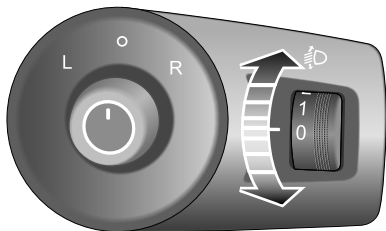

Position 0 is the initial position of the headlamp levelling adjustment switch. The headlamp levelling adjustment can be made as per the following table according to the vehicle load.

Location	Load
0	Driver, or driver & front passenger.
1	All the seats occupied with no load.
2	All the seats occupied plus an evenly distributed load in the boot, or driver with full load.
3	Driver only, plus an evenly distributed load in the boot.

## Fog Lamp Switch



*Fog lights should only be used when visibility is below 100m - other road users could be dazzled in clear conditions.*

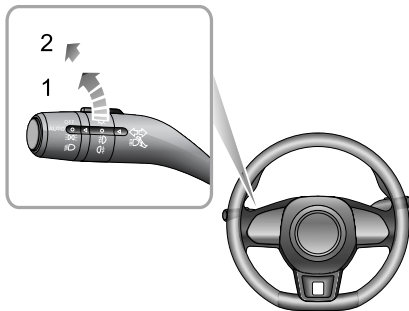

## Front Fog Lamps \*

With the ignition switch in the ON position and the side lights on, turn the fog lamp switch to position 1 to turn

on the front fog lamps. The indicator illuminates in the instrument panel when the front fog lamps are on.

## Rear Fog Lamps

With the ignition switch in the ON position and the headlamps or front fog lamps on, turn the fog lamp switch to position 2, this will turn on the rear fog lamps, release the switch to allow it to return to position 1. The indicator illuminates in the instrument panel when the rear fog lamps are on.

# INSTRUMENTS AND CONTROLS

## Direction Indicator/Main Beam Switch



*Take care not to dazzle oncoming vehicles when driving using main beam headlamps.*

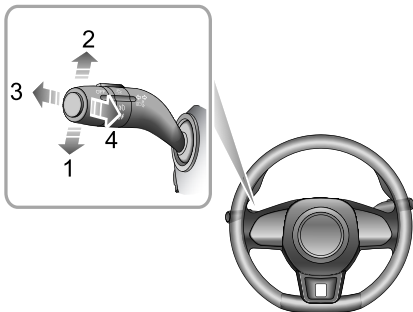

## Direction Indicators

Move the lever down to indicate a LEFT turn (1). Move the lever up to indicate a RIGHT turn (2). The corresponding

GREEN indicator lamp in the instrument pack will flash when the turning signal lamps are working.

Rotating the steering wheel will cancel the indicator operation (small movements of the steering wheel may not operate the self cancelling). To indicate a lane change, move the lever briefly and release, the indicators will flash three times and then cancel.

## Headlamp High/Low Beam Switching

With the ignition switch in the ON position and the master lighting switch turned to position 3, or the auto function has switched the lights on, push the lever (3) towards the instrument panel to turn on headlamp high beams. The high beam indicator lamp in instrument pack illuminates, press the lever (3) again to switch to headlamp low beams.

## High Beam Flash

To briefly flash the high beam on and off, pull the lever towards the steering wheel (4) and then release.

## Hazard Warning Lamp

Press the hazard warning lamp button  to turn on the hazard warning lamps. The turning signal lamps and direction indicator lamps will flash together. Press the button again to switch off the hazard warning lamps. All turning signal lamps and direction indicator lamps will stop flashing. For more details and location refer to 'Emergency Information' 'Hazard Warning Devices'.

# INSTRUMENTS AND CONTROLS

## Wipers and Washers

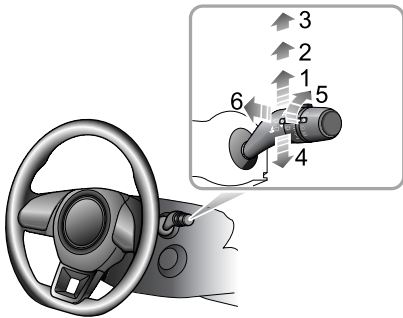

### Windscreen Wiper Operation

The wipers and washers will only operate with the ignition switch in the ACC or ON position. Operate the lever to select different wipe speeds:

- Intermittent wiper (1)
- Slow wiper (2)

- Fast wipe (3)
- Single wipe (4)
- Intermittent wipe frequency adjustment (5) \*
- Programmed wash/wipe (6)

### Intermittent Wipe

By pushing the lever up to the Intermittent wiper position (1), the wipers will operate automatically. Turn the switch (5) \* to adjust the intermittent wipe frequency. This speed will also change with the vehicle speed. As the vehicle speed increases, the wiper frequency increases. As the vehicle speed decreases, the wiper frequency decreases.

### Slow Wipe

By pushing the lever up to the slow wipe position (2), the wipers will operate slowly. Move the lever to re-select the wipe speed.

### Fast Wipe

By pushing the lever up to the fast wipe position (3), the wipers will operate fast. Move the lever to re-select the wipe speed.

## Single Wipe

Pressing the lever (4) down and releasing will operate a single wipe, if the lever is held down, the wipers will operate at high speed until the lever is released.

### IMPORTANT

- Avoid operating the wiper on a dry windscreen.
- In freezing or extremely hot weather conditions, make sure that the wiper blades are not frozen/adhered to the windscreen.
- In winter, remove snow or ice from around the arms and blades, including the wiped area of the screen.

### IMPORTANT

If the washers fail to deliver the screen wash solution (dirt or ice may have blocked the jets), release the lever immediately. This will prevent the wipers from operating, and the consequent risk of visibility being impaired by dirt smearing across the unwashed windscreen.

## Programmed Wash/Wipe

Pulling the lever toward the steering wheel (6) will operate the windscreen washers. After a short delay, the wipers will commence operating in conjunction with the washers.

**Note:** *The wipers continue operating for a further three wipes after the lever is released. After several seconds, there will be a further wipe to remove any fluid draining down the screen.*

# INSTRUMENTS AND CONTROLS

## Rear Window Wiper Operation

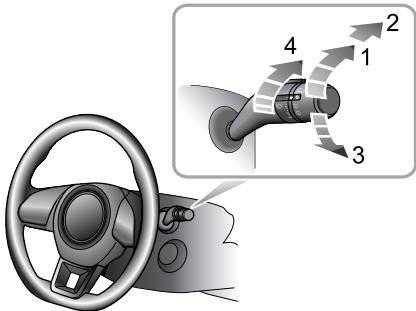

- Intermittent wipe (1)
- Wash and wipe (2)
- Wash and wipe (3)
- Intermittent wipe frequency adjustment (4) \*

The rear window wiper and washer will only operate with the ignition switch in the ON position. Turn the rear window wiper switch to intermittent wipe (1), the rear window wiper will operate, after 3 consecutive wipes, the

wipers will enter into intermittent mode. The time period between the wipes can be increased/decreased via the intermittent wipe frequency adjustment switch (4).

Turn the rear window wiper switch to wash and wipe (2) position and hold, the rear window wiper and washer will operate, the rear window wiper wipes quickly. release the switch allowing it to return to intermittent wipe (1), the rear window washer will stop operating, and the wiper wipes slowly, change the stalk switch position 4 \* to adjust the wipe speed.

Turn the rear window wiper switch to wash and wipe (3) and hold, the rear window wiper and washer will operate. release the switch allowing it to return to OFF position, the rear window washer will stop operating, and the rear window wiper wipes for 3 times, after several seconds, the wiper will wipe once more to remove the washer fluid on the windscreen.

**Note: When the tailgate is opened, rear window wiper operations will be disabled.**



**Note:** *When the windscreen wipers are switched on, if the shift lever is in R position, the rear window wiper will operate.*

# INSTRUMENTS AND CONTROLS

---

## Steering System

### Adjustment of Steering Column



**DO NOT attempt to adjust the angle of the steering column while the vehicle is in motion. This is extremely dangerous.**

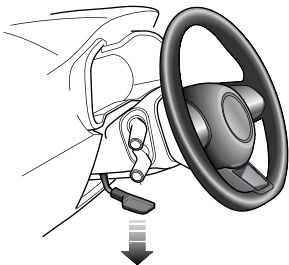

To adjust the angle of the steering column to suit your driving position:

- 1 Fully release the locking lever.
- 2 Hold the steering wheel in both hands and tilt the steering column up or down to move the wheel into the most comfortable position.
- 3 Once a comfortable driving position has been selected, pull the locking lever fully up to lock the steering column into its new position.

## Electric Power Steering



*If the electric power steering fails or cannot operate the steering will appear very heavy, this will affect driving safety.*

The electric power steering system only works when the engine is running. The system operates via a motor with assistance levels automatically adjusted based on vehicle speed, steering wheel torque and steering wheel angle.

### IMPORTANT

Holding the steering wheel on full lock for long periods will result in a reduction in power assistance causing a heavier feel to the steering for a short period of time.

## Steering Mode Switching \*

The electric power steering system provides 3 different steering modes:

- 1 Normal: provides moderate power assistance.
- 2 Urban: provides a high level of assistance, with a light feel.
- 3 Dynamic: provides low level power assistance, with a heavier feel.

The steering mode is selectable for vehicle speeds up to 60 mph (100 km/h) through the touch screen interface, please refer to "Driving and Maintenance" under "Vehicle Settings" in the "Air Conditioning and Audio Systems" section.

## Electric Power Steering (EPS) Warning Lamp

See "Warning Lamps and Indicators" under the "Instruments and Controls" section.

# INSTRUMENTS AND CONTROLS

---

## Horn



Press the horn button area (indicated by arrow) on the steering wheel to operate the horn.

**Note:** *The vehicle horn press location and the driver's airbag are located in close proximity on the steering wheel. The illustration shows the position of the horn switches, please ensure that you press in this area to*

**avoid any potential conflict with the operation of the airbag.**

### IMPORTANT

To avoid possible SRS issues, please **DO NOT** press with excessive force or hit the airbag cover when operating the horn.

## Mirrors

### Door Mirrors

**Note:** Objects viewed in exterior mirrors may appear further away than they actually are.

### Electric Door Mirror Glass Adjustment

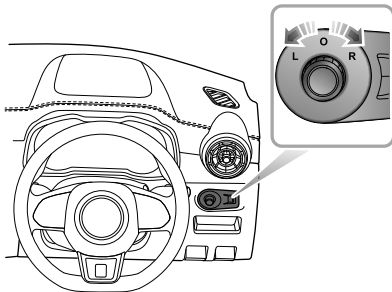

- When the ignition switch is in ACC or ON/RUN/START position, rotate the knob to select left (L) or right (R) rearview mirror.
- Move the knob in the desired direction to adjust the angle of the exterior mirror glass.
- Upon completion of the adjustment, rotate the knob back to the central position, this will ensure no accidental adjustment of the mirror.

### Heating Elements \*

The door mirrors have integral heating elements which disperse ice or mist from the glass. The heating elements operate while the Heated Rear Window  is switched on.

**Note:** The heating elements of rear window and mirror will only work when the engine is running.

### Mirror Folding

The mirrors can be folded back manually towards the side windows into a 'park' position to enable the car to negotiate narrow openings and avoid collisions.

# INSTRUMENTS AND CONTROLS

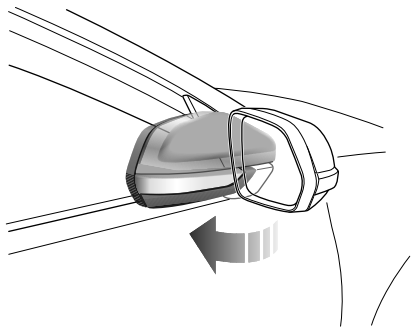

## IMPORTANT

- Exterior rearview mirror glass adjustments are operated by electrical motors. Operating them directly by hand may damage the internal components.
- Washing or flushing exterior rearview mirrors with high pressure water jets or car washes may result in electrical motor failure.

## Interior Rear-view Mirror

Before driving, adjust the body of the mirror by hand to achieve the best possible view to the rear. The manual dipping function of the interior rear-view mirror helps to reduce glare from the headlights of following vehicles at night.

## Manual Mirror

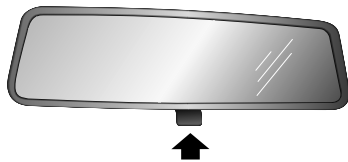

Move the lever at the base of the mirror forward to 'dip' the mirror. Normal visibility is restored by pulling the lever back again.

*Note: In some circumstances, the view reflected in a 'dipped' manual mirror can confuse the driver as to the precise location of following vehicles.*

# INSTRUMENTS AND CONTROLS

## Sunvisors



**The vanity mirror on the driver side should only be used when the car is stationary.**

Sunvisors (1) are arranged on the roof ahead of both the driver and the front passenger. Some models have vanity mirror (2), depending on the vehicle configuration. For the models which have vanity mirror, pull the sunvisor downward and slide the cover aside to use the vanity mirror.

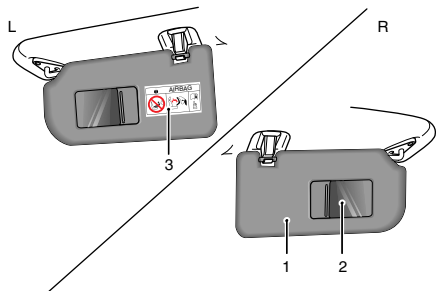

**Note: Warnings and instructions on use of child restraint (3) are attached to both sides of the sunvisor of passenger.**



## Windows

### Power Operated Window Switch

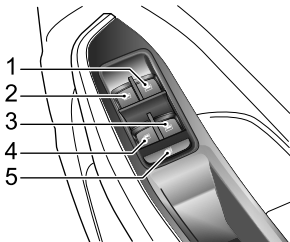

- 1 Front Right Window Switch
- 2 Front Left Window Switch
- 3 Rear Right Window Switch
- 4 Rear Left Window Switch
- 5 Rear Window Isolation Switch

### Window Operation



*Ensure children are kept clear when raising or lowering a window.*



*Improper use or activation of the electric windows by children could cause serious harm or even death. It is the responsibility of the driver and adult passengers to ensure that when carrying children the necessary steps are taken to isolate the window operation. This should include the removal of the ignition key when children are left alone in the vehicle.*

Push the switch (1-4) down to lower, and pull the switch up to raise the window. The window will stop moving as soon as the switch is released (unless the 'One-Touch' function is active).

**Note:** *The front and rear passenger windows can also be operated by individual window switches, mounted on each door. The rear window switches will not be*

# INSTRUMENTS AND CONTROLS

---

*operated if the rear window isolation switch has been activated.*

**Note:** *The electric window can be operated with the ignition in position ACC or in position ON/RUN/START (For safety: doors should be closed).*

## Rear Window Isolation Switch

Press the button (5) to isolate the rear window controls, press again to restore control.

**Note:** *It is recommended that you ISOLATE the rear window switches when carrying a child.*

## “One-Touch” Down

The driver's window control switch (1) has 2 positions. Short press the window control switch to the "2" position and release. The window automatically descends to fully open. Window movement can be stopped at desired position at any time by briefly pulling up the corresponding switch during descent.

## “One Touch” Up with “Anti-Trap” \*

On some models the driver's window (1) has the “one-touch” up function. Lifting the switch to the "2" position for a short time and releasing will automatically close the window completely. Window movement can be stopped at a desired position at any time by briefly operating the switch again.

The “Anti-Trap” function is a safety feature which prevents the window from fully closing if an obstruction is sensed - if this happens the window will open slightly to allow the obstruction to be removed.

**Note:** *DO NOT operate the power window controls continuously several times in a short time frame, otherwise the power window controls may be disabled to protect the motor. If this occurs, please wait a few seconds until the motor cools down. In the case of the driver's window with "One Touch and Anti-Trap" please wait 30 seconds prior to operation. In some cases it may take 30 minutes to completely cool down, during which time the negative battery lead should not be disconnected.*

*Note: If the battery is disconnected, the “One-Touch” and “Anti-Trap” features will be lost. To restore this feature, fully open and then fully close the window holding the switch for 5 seconds in the closed position.*

# INSTRUMENTS AND CONTROLS

---

## Interior Lights

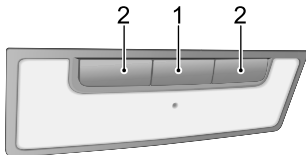

Press any one of buttons (2) to switch on the corresponding lamp, and press it again to switch the lamp off.

## Automatic Operation

Press the interior lights switch button (1) to turn on automatic operation, and press it again to turn off the function.

Interior light illumination occurs automatically whenever the following occur.

- The car is unlocked.
- Any door or the tailgate is opened.
- The ignition is switched off, providing the sidelights have been illuminated during the previous 30 seconds.

**Note:** *If a door or the tailgate is open for more than 15 minutes, the front interior lamp will be switched off automatically to avoid battery drain.*

## Front Power Socket



*Please ensure the socket blanking plug is inserted when the power socket is not in use. This will ensure no debris or foreign objects enter the socket preventing its use or cause short circuits.*



*The 12V power socket has a voltage rating of 12V, and the maximum power of 120 Watt, please DO NOT use any electrical appliance that exceeds this rating.*



*Extended use of the accessory power socket and USB socket when the engine is switched off will cause premature discharging of the vehicle battery.*

The 12V power socket is located in the centre console in front of the gear shift lever. It can be used as a power supply when the ignition switch is in the ACC or ON/RUN/START positions when the blanking plug is removed.

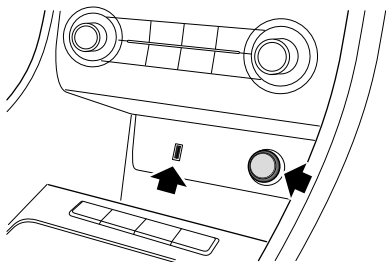

Located to the left of the power socket is one USB socket. It can be used to provide a 5V power supply or a data transmission connection.

**Note: The vehicle is not supplied with a cigar lighter. If required please contact your local MG Authorised Repairer.**

# INSTRUMENTS AND CONTROLS

---

## Storage Devices

### Instructions

- Please close all storage devices when the vehicle is in motion. Leaving these storage devices open may cause personal injury in cases of a sudden start-off, emergency braking and a car accident.
- Do not place flammable materials such as liquid or lighters in any storage devices. The heat in hot conditions may ignite flammable materials and lead to a fire.

### Glove Box

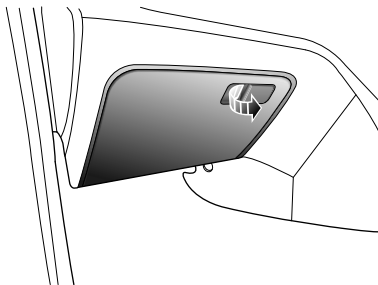

To open the glove box, pull the handle on the glove box cover (as indicated by the arrow).

Push the box cover forward to close the glove box. Make sure the glove box is fully closed when the vehicle is in motion.

## Card Box

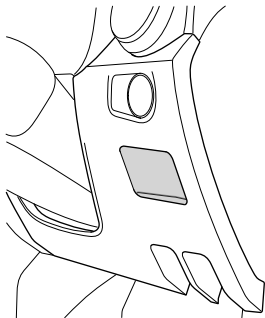

Located in the driver side lower dash trim panel.

## Loadspace



**DO NOT** place articles on the rear parcel shelf, they could move causing personal injury in the event of an accident , emergency braking or hard acceleration.

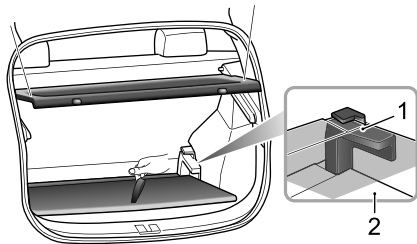

The rear parcel shelf is connected to the tailgate using straps and hooks. When opening the tailgate the shelf will automatically be raised.

## **INSTRUMENTS AND CONTROLS**

---

The spare wheel/tyre repair kit and tool kit are stowed beneath the loadspace carpet, lift the carpet for access. Always refit the carpet after use.

In addition, The loadspace carpet height can be adjusted by using the carpet bracket (figure 1, 2).



## Cup Holder



**DO NOT** place hot drinks in the cup holder whilst driving. Spillage may result in personal injury or damage.

## Centre Console Cup Holder

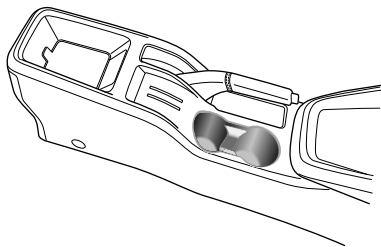

The centre console cup holder is located at the middle of the console .

# INSTRUMENTS AND CONTROLS

---

## Roof Luggage Rack \*



**Roof loads *MUST NOT* exceed the maximum authorised load. This may lead to injury or vehicle damage.**



**Loose or improperly fixed loads may fall from the roof luggage rack and lead to an accident or cause people injured.**



**When heavy or large items are carried on the roof luggage rack it may lead to changes in steering, handling and braking characteristics. Please avoid sharp manoeuvres, heavy braking and excessive acceleration.**

Pay attention to the following in using the roof luggage rack:

- Secure loads at the front of the roof as far as possible. distribute loads evenly.
- DO NOT use automatic car washes with loads on the roof luggage rack.

- The overall height of the car is different when loads are fitted to the roof luggage rack. Please ensure there is adequate clearance when entering tunnels and garages.
- Ensure the loads carried by the roof luggage rack do not impede operation of the sunroof, roof antenna or tailgate opening.
- When installing or removing a piece of loading equipment, follow the instructions provided by the manufacturer of the loading equipment.

### Maximum Authorised Load for the Roof

The maximum authorised load for the roof is 75 kg, this includes the weight of the roof loads and that of the loading equipment installed.

Ensure you are aware of the weight of loads, and weigh them when necessary. Never exceed the maximum authorised load for the roof.

### Periodical Check

Always check the condition of the bolt connectors and fastenings before use. Periodically check the bolt connectors and fastenings for security.

## **Air Conditioning and Audio Systems**

---

- 60 *Ventilation*
- 63 *Manual Temperature Control \**
- 66 *Electronic Temperature Control \**
- 70 *Radio \**
- 78 *Entertainment System \**

# AIR CONDITIONING AND AUDIO SYSTEMS

---

## Ventilation

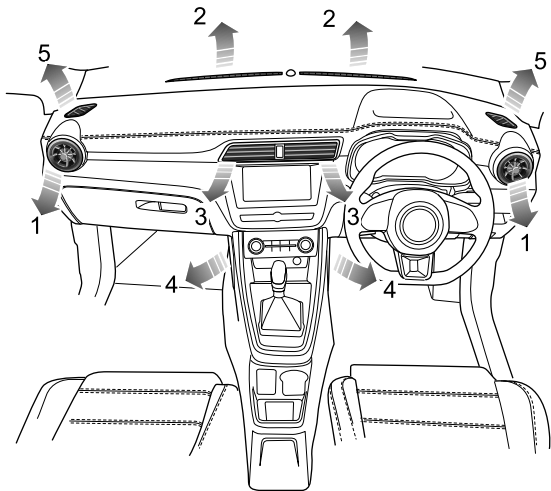

- 1 Side Vents
- 2 Windscreen Vents
- 3 Centre Vents
- 4 Front Seat Feet Vents
- 5 Front Side Window Vents

## AIR CONDITIONING AND AUDIO SYSTEMS

The heating, ventilation and air conditioning system provides fresh, cooling or heated air to the interior of the car from the air intake grille in front of the windscreen.

Always keep the air intake grille clear of obstructions such as leaves, snow or ice.

### Particle/Pollen Filter

The particle/pollen filter helps to keep the car interior free from pollen and dust. To remain fully effective, the filter should be replaced at the recommended service interval.

### Vents

#### Centre Vents

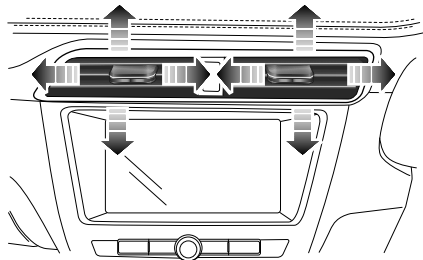

Toggle the button right all the way to close the vent, and toggle the button left to open the vent. Toggle the button at the centre of the vent up and down, left and right to regulate the air direction.

# AIR CONDITIONING AND AUDIO SYSTEMS

---

## Side Vents

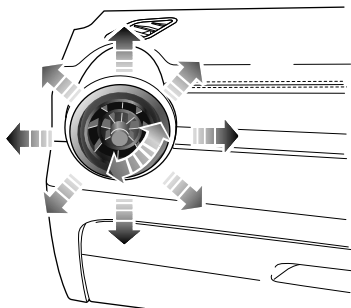

Rotate the centre thumb-wheel clockwise to open the vent and anti-clockwise to close the vent. Toggle the centre thumb-wheel up, down, left or right to adjust the air direction

# AIR CONDITIONING AND AUDIO SYSTEMS

2

## Manual Temperature Control \*

### Control Panel

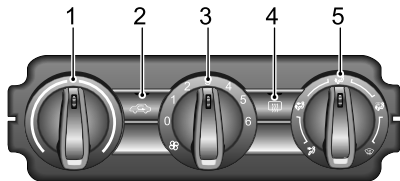

- 1 Temperature Control Knob
- 2 Air Recirculation Button
- 3 Blower Motor Speed Control
- 4 Heated Rear Window Button
- 5 Air Distribution Control Knob

### Temperature Control

Rotate the Temperature Control Knob clockwise to increase the air temperature inside the car or rotate anti-clockwise to decrease.

### Air Recirculation



Press to operate, the **LED** in the switch illuminates, the air inside the car is recirculated and the air intake is closed, preventing the entry of traffic fumes.

When the engine is off, the air recirculation control flap stays in current position.

**Note:** Leaving the system in recirculation mode can cause the windscreen to mist. If this happens, switch off recirculation and rotate the air distribution knob to **Windscreen/Demist mode** and adjust the blower speed to **maximum**.

### Blower Motor Speed Control

Rotate the Blower Motor Speed Control clockwise/counterclockwise to increase/decrease the

## AIR CONDITIONING AND AUDIO SYSTEMS

---

blower speed. The blower is switched off when the blower motor control is set to 0, and the blower motor speed increases gradually from 1 to 6.

**Note:** To turn off the system, adjust the blower motor control to 0; to turn on the system, adjust the blower motor control to other position.

### Heated Rear Window



*The heating elements on the inside of the rear screen are easily damaged. DO NOT scrape or scratch the inside of the glass. DO NOT stick labels over the heating elements.*



Press to operate; the **LED** in the switch will illuminate indicating the heated rear window is switched on. The **LED** extinguishes when the heated rear window is turned off. The heated rear window will switch off automatically after **15** minutes.

**Note:** The heated rear window will only function with the engine operating.

### Air Distribution

Rotate the Air Distribution Control Knob, select the air distribution mode as required.



For 'face'. Directs air to the side and centre vents.



For 'face + feet'. Directs air to the front seat feet, side and centre vents.



For 'feet'. Directs air to the front seat feet vents.

**Note:** In this mode, a small amount of air will be directed to the side, windscreen and front side window vents.



For 'feet + windscreen'. Directs air to the windscreen, front side window and front seat feet vents.



## AIR CONDITIONING AND AUDIO SYSTEMS

---

**Note:** *In this mode, a small amount of air will be directed to the side vents.*



For 'windscreen'. Directs air to the windscreen and front side window vents.

**Note:** *In this mode, a small amount of air will be directed to the side vents.*

# AIR CONDITIONING AND AUDIO SYSTEMS

---

## Electronic Temperature Control \*

### Control Panel

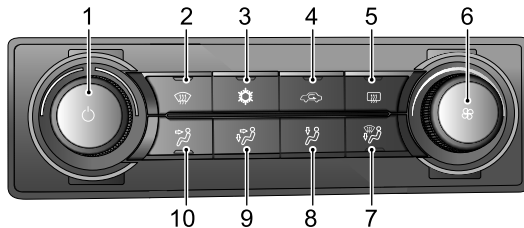

- 1 Temperature Control Knob/System On/Off Button
- 2 Defrost/Demist Button
- 3 A/C On/Off Button
- 4 Air Recirculation Button
- 5 Heated Rear Window Button
- 6 Blower Motor Speed Control
- 7 For 'feet + windscreen'
- 8 For 'feet'
- 9 For 'face + feet'
- 10 For 'face'

## System On/Off



Press the System On/Off Button on the control panel to switch the system on, and all functions revert to the state before shutdown. Press again to switch off.

## Blower Motor Speed Control

Rotate the Blower Motor Speed Control clockwise/counterclockwise to increase/decrease the air volume.

## Temperature Control

Rotate the Temperature Control Knob clockwise to increase the air temperature inside the car or rotate anti-clockwise to decrease.

## A/C On/Off



Press to operate; the **LED** in the switch will illuminate indicating air cooling function is switched on. Press again to switch off.

### Note:

- 1 A/C will only operate when the engine is running.*
- 2 The heating function is still available, when the air cooling is switched off.*
- 3 A small amount of water may remain in the air conditioner after usage, this may produce a peculiar smell. If this is a particular issue, it is recommended to switch off the cooling function and run the blower for a while with the engine running prior to switching off.*

## Air Distribution

Press the Air Distribution button, select the air distribution mode as required.



For 'face'. Directs air to the side and centre vents.



For 'face + feet'. Directs air to the front seat feet, side and centre vents.

# AIR CONDITIONING AND AUDIO SYSTEMS

---



For 'feet'. Directs air to the front seat feet vents.

**Note:** *In this mode, a small amount of air will be directed to the side, windscreen and front side window vents.*



For 'feet + windscreen'. Directs air to the windscreen, front side window and front seat feet vents.

**Note:** *In this mode, a small amount of air will be directed to the side vents.*

## Defrost/Demist



Press the Defrost/Demist Button on the control panel, and the indicator will illuminate. The system will automatically set itself to a preset temperature and blower motor speed to effectively clear the side windows and windscreen.

Press again to switch off. Then the indicator will go off, and the system will return to the previous state.

Whilst the defrost/demist is selected, operate the A/C on/off button to turn on/off the compressor; operate the air recirculation button to switch between internal circulation and external circulation, operation of either of these functions will not affect the defrost/demist function, operation of any other air distribution modes will quit defrost/demist.

## Heated Rear Window



**The heating elements on the inside of the rear screen are easily damaged. DO NOT scrape or scratch the inside of the glass. DO NOT stick labels over the heating elements.**



Press to operate; the **LED** in the switch will illuminate indicating the heated rear window is switched on. The **LED** extinguishes when the heated rear window is turned off. The heated rear window will switch off automatically after **15** minutes. After the heated rear window is closed, if switched on again within **5** minutes, The heated rear window will switch off automatically after **8** minutes.

**Note:** *The heated rear window will only function with the engine operating.*

### Air Recirculation



Press to operate, the **LED** in the switch illuminates, the air inside the car is recirculated and the air intake is closed, preventing the entry of traffic fumes.

When the engine is off, the air recirculation control flap stays in current position.

**Note:** *Recirculation mode is automatically activated when reverse gear is selected.*

**Note:** *Leaving the system in recirculation mode can cause the windscreen to mist. If this happens, switch off recirculation and turn the controls to maximum demisting.*

# AIR CONDITIONING AND AUDIO SYSTEMS

---

## Radio \*

### Instructions

- 1 When cleaning the vehicle, ensure that water does not contact to the audio system.
- 2 Use a soft cloth to clean the display. Use alcohol to remove stubborn dirt. Do not use water, solvent or abrasive cleaner, these substances will damage the display.
- 3 The radio is designed to operate between temperatures of  $-20^{\circ}\text{C} \sim 70^{\circ}\text{C}$ . When the temperature is very low in the vehicle, do not use this device immediately after switching on the heater.
- 4 Distortion, interference and lack of signal clarity, are often attributed to a fault in the radio. Problems of this kind are usually caused by atmospheric conditions, signal strength, hilly terrain, tall buildings, bridges and even electrical interference from power lines.
- 5 The USB interface of the player does not support a portable hard drive.
- 6 The USB interface will only support some makes and models of card reader, operation is not guaranteed.
- 7 The USB interface does not support connection to USB hubs or extensions.
- 8 The USB interface may not be able to identify certain USB brands and models, not all file types are supported. Seek an MG Authorised Repairer.
- 9 The USB interface supports the recharging function, and the unit can only play the music tracks stored in the mobile phone set as the mass storage device; Apple devices are not supported.

IMPORTANT
Only use the radio controls when traffic conditions permit.

# AIR CONDITIONING AND AUDIO SYSTEMS

## Radio Control Panel



- 1 Preset button [1]
- 2 Preset button/Random button [2]
- 3 Preset button/Repeat button [3]
- 4 [ON/OFF] button/[VOL] knob
- 5 Bluetooth telephone [5]
- 6 [SRC] button
- 7 [USB] port
- 8 [REVERSE] button
- 9 [NEXT] button
- 10 [MENU] button
- 11 Microphone
- 12 Preset button/Next folder [6]
- 13 Preset button/Previous folder [5]
- 14 Preset button/Information button [4]

# AIR CONDITIONING AND AUDIO SYSTEMS

---

## Basic Operations

### Power On/Off

Press the [ON/OFF] button to start the system, and press it again to turn off the system.

### 30 Minutes Playback Function

With the ignition off, press the [ON/OFF] button to power on the system. After 30 minutes the unit will be switched off automatically. Press the [ON/OFF] button again to resume the radio function.

**Note:** *To avoid low battery and start failure, this function should be used in moderation.*

### Volume Adjustment

Turn the volume button (VOL) in a clockwise direction to increase the volume in increments of 1, the maximum volume is 32. Turn the volume button (VOL) in a counter-clockwise direction to decrease the volume in increments of 1, the minimum volume is 0. When the [M] appears in the display, it indicates that the device is in the state of mute.

## Menu Functions

Short press [MENU] button to enter into the menu functions, rotate the [MENU] button to display each function in turn, and press it again to enter the sub-menu.

In [BASS] mode, turn the button to adjust the bass effect (-7 ~ +7).

In [TREBLE] mode, turn the button to adjust the treble effect (-7 ~ +7).

In [BALANCE] mode, rotate the button to adjust the balance effect (L7 ~ R7).

In [EQ] mode, rotate the button, and the sound effect will cycle through the CLASSIC, ROCK, POP, JAZZ, VOCAL and FLAT.





In [LOUDNESS] mode, rotate the button to switch off/on the loudness.

### Playback Mode

In the USB playback mode, short press [2] or [3] button to select random or repeat mode.



## Folder Mode

In the USB playback mode, short press [5 ] or [6 ] button to enter into folder selection mode; short press [5 ] or [6 ] again to select the folder upward or downward.

## Radio Function

### Band Selection



Press [SRC] button to select bands of FM1, FM2, FMA and AM.

**Note:** *If the station plays in stereo mode, the screen will display "ST" at the bottom.*

### Tuning

The system provides 3 tuning modes, automatic, manual and pre-set tuning.

#### Automatic Tuning

Short press the [] button or [] button, the radio automatically searches the frequency range, looking for a radio station of acceptable strength. Once a station is found, that station will be played.

#### Manual Tuning

In the radio mode, rotate the [MENU] button to search the station manually.

# AIR CONDITIONING AND AUDIO SYSTEMS

---

## **Preset Tuning**

The memory has 24 preset positions (FM1, FM2, FMA and AM) for storing stations. Press the numeric button 1 ~ 6 to automatically select a station frequency stored.

## **Storing a Station**

The system can provide 2 storing modes: manual storing and auto storing.

### **Manual Storing**

- Press [SRC] button to select the desired waveband.
- Use auto search, manual search or preset search to select the desired station.
- Long press (more than 2s) any preset button to store the current station frequency into the preset memory (the screen displays the station waveband and frequency stored).

**Note:** *If there is a station already stored in the memory, it will be overwritten by the newly stored station.*

### **Auto Storing**

In the desired waveband, long press [SRC] button, the 6 strongest FM/AM station frequencies will be stored in the memory of FMA or AM in order of signal strength. If the auto-store is unable to find 6 strong stations, the stations previously stored in the memory positions will be retained and not be overwritten.

When [AST] appears in the display, it indicates that received stations are being stored automatically.

**Note:** *The auto-store will overwrite all stations already stored by the FMA or AM preset button.*

### **Scanning for a Station**

In FM or AM mode, long press the [MENU] to search for stations automatically. When a station signal is located, the unit will stop searching and play the current station for 10s, and the frequency will flash 10 times in the display. If you want to stick to the current station, long press the [MENU] button again. If not, the unit will search for the next station automatically after 10s's playback.

# AIR CONDITIONING AND AUDIO SYSTEMS

When [SCAN] appears in the display, it indicates that the stations are being searched.

## USB Mode



2

Insert a USB memory stick via the USB connection.

When [←] appears in the display, it indicates that the USB device has been connected. When [⚡] appears, it indicates that the external device is recharging.

## USB Playback

Press [▶▶] button once to select the next track to play.

# AIR CONDITIONING AND AUDIO SYSTEMS

---

Press [⏮] button once, if the playing time exceeds 3 seconds, the track will be played from the beginning, press the button again to select to play the previous track; if the playing time does not exceed 3 seconds, press [⏮] button once, to play the previous track.

During playback, [🔀] in the display indicates that tracks are played in random mode, and [🔁] stands for the repeat mode. Select the mode by short pressing [2⏮] button or [3🔁] button.

**Note:** *The system can only play the files in mp3 and wma formats.*

## USB Removal

Do not forcibly remove the USB when USB files are displayed, this may cause file damage.

## Bluetooth Connection

The default device name displayed on the system is SAIC-BT.

Turn on Bluetooth function of the mobile phone and search for the vehicle Bluetooth device to pair, the display will

indicate if the mobile phone is connected to the system. If the Bluetooth device is enabled but not connected to the system, it will search and automatically attempt to connect with the last device that was paired to the system.

[📶] in the display indicates that the Bluetooth has been connected.

## Bluetooth Music

Press SRC to switch to the Bluetooth music playback mode. In this mode, track selection (upward/downward) operation can be made on the on-board entertainment system, while the functional switch between fast-forward/rewind, track selection (upward/downward) and the random/repeat mode can be made on the Bluetooth device. (some Bluetooth devices do not support this function), of which the operation method is same as the USB.

## Bluetooth Phone

With a mobile phone connected, if there is an incoming call, the current track will be stopped and the call number will be displayed instead. Press [📞] to accept the Bluetooth

call. Long press [📞] to end the call. Short press [📞] button during the phone call to shift between the private conversation and the hands-free function.

### Bluetooth Function Menu

With Bluetooth paired, short press [MENU] button to enter into the Bluetooth menu; rotate the [MENU] button to select the Bluetooth settings.

### Phone Volume Setting

Short press [MENU] button on the Bluetooth volume setting interface to enter into the volume control interface; rotate the [MENU] button to adjust the volume and short press the [MENU] button again to store settings and then return to the previous menu.

**Note:** *This setting can only adjust the volume in the Bluetooth hands-free call, and makes no impact on other playback modes.*

### Bluetooth Pairing

Short press [MENU] button on the Bluetooth pairing interface to display the pairing code.

**Note:** *The function only supports the Bluetooth pairing connection of mobile phone that require you to enter the pairing code.*

# AIR CONDITIONING AND AUDIO SYSTEMS

---

## Entertainment System \*

### Important Safety Information

- Do not attempt to fit, repair or modify the entertainment system by yourself, because there are high-voltage components in the device, which may cause electric shock. For internal inspection, adjustment or repair, please consult a local Authorised Repairer.
- Do not allow this entertainment and navigation system to come into contact with liquids. If liquids or foreign objects enter into this entertainment and navigation system, pull over as soon as safety permits, immediately switch off the ignition and contact a local MG Authorised Repairer. Do not use the entertainment and navigation system in these circumstances because doing so may result in a fire, electric shock, or other failure.
- If you notice smoke, abnormal noises or odours from the entertainment system, or any other abnormal signs on the screen, switch the ignition off immediately and contact a local MG Authorised Repairer for service.

Using this entertainment system in these circumstances may result in permanent damage to the system.

- Operation of the navigation or video functions of the system is prohibited whilst the vehicle is in motion. MG Motor UK accepts no responsibility for any consequences caused by this operation. Please park your vehicle in a safe location and apply the parking brake before making the necessary adjustments or watching "Video".
- Particularly high or particularly low temperatures will interfere with normal operation. If the vehicle engine is not running, and parked in direct sun or in a cold location for a long time, the car may become particularly hot or cold, in this environment the system may not work properly. Once the temperature inside the car is back to normal, the system will resume normal function. If it does not resume, please contact an MG Authorised Repairer for assistance.
- Switch off entertainment and navigation system during refuelling.
- Be sure to run the vehicle engine while using this entertainment and navigation system. Using this

entertainment and navigation system without running the engine can drain the battery.

- If the battery is disconnected or discharged, the data stored in the memory of this entertainment and navigation system will be erased.
- When using a mobile phone, keep the antenna of the mobile phone away from the screen to prevent the disruption of video signal in the form of spots, coloured stripes, etc. on the screen.
- To protect the screen against damage, be sure to touch the panel buttons with your finger (a touch pen can be used for special calibration).
- The navigation system is designed only as a guide and does not relieve the driver of the responsibility for driving in accordance with traffic regulations.

### Warnings for Screen Use



***To protect the screen against damage, always touch the panel buttons with your finger. A touch pen may be used for special calibration. The touch pen should not be used for normal operation. The screen will not display the home screen at power on in suspend mode.***

- Please take care to protect the screen against direct sunlight. Extended exposure to direct sunlight will result in screen malfunction due to high temperature.
- When the temperature is beyond the operating temperature range ( -20°C to +65°C), please do not use the screen, because the screen may not operate normally and could be damaged.
- Make sure that the warm or cool air flow from the air conditioner is not distributed on the screen directly, damage to the entertainment device may occur due to heat or moisture.
- Do not use excessive force to drag and drop or press the screen, damage or scratching may occur.

# AIR CONDITIONING AND AUDIO SYSTEMS

---

- To remove dust from the screen or clean the screen, please turn the system off first, then wipe with a dry soft cloth. When wiping the screen, take care not to scratch the surface. Do not use irritative or abrasive chemical cleaners.
- When the backlight reaches the end of its service life, the screen will become dimmer and the image will no longer be visible, please contact a local MG Authorised Repairer.

**Note:** *The images in this manual are illustrations only for your reference.*

**Note:** *Along with the product improvement, specifications and designs are subject to change without any prior notice.*

**Note:** *All rights related to this document are reserved.*

**Note:** *Without the permission of the copyright owner, reproduction and usage of this document in any form, either in whole or in part, is strictly prohibited.*

## Playable File Format for Entertainment System

### Precautions

- Some types of external storage devices may not be recognised. This may result in the files not being played or displayed correctly.
- Because of file characteristics, file format, recorded application, playback environment, storage conditions and other factors, it may not be possible to play the files normally.

### Audio Support

The entertainment system supports the following audio formats, other formats may not work normally.

MP3, WMA, AAC, OGG, ID3 Tag info, WAV, APE and FLAC.

### Video Support

The entertainment system supports the following video formats, other formats may not work normally.

WMV, H264, MPEG2, MPEG4 and HD Video Playback.



# AIR CONDITIONING AND AUDIO SYSTEMS

## Supported Texts/Images

The entertainment system supports the following text/image formats, other formats may not work normally.

JPEG, GIF, BMP, PNG.

## iPod/iPhone Compatibility

The entertainment system supports IOS 6.0 or higher version, other models or versions may not work correctly.

## Basic Operations

### Entertainment Player Control Panel

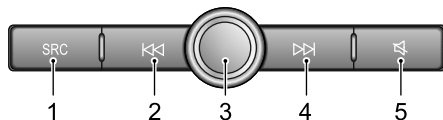

- 1 SRC: Switch to next available multimedia function.
- 2 : When playing audio, short press to return to the beginning of the track (except the Bluetooth music mode), short press again to switch to previous track, and long press to rewind (except the Bluetooth music mode). When playing video, short press to switch to previous video, and long press to rewind. When playing the radio, short press to switch to previous station; long press to search and play the previous station; long press continuously, the system will search through a cycle, then stop at the current station and continue to play it.

# AIR CONDITIONING AND AUDIO SYSTEMS

- 3 Power Button/Volume Knob: short press to shift between working state and suspend state. Long press for 10 seconds to restart the system. Rotate to adjust the system volume.
- 4 ▶▶: When playing an audio/video, short press to switch to next track/video (except the Bluetooth music mode), and long press to fast forward. When playing the radio, short press to switch to next station; long press to search and play the next station; long press continuously, the system will search through a cycle, then stop at the current station and continue to play it.
- 5 🔇: Mute/Cancel Mute

## Main System Interface

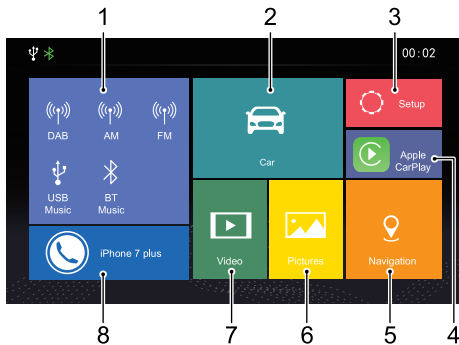

- 1 Radio/Music  
Touch to enter the Radio/Music interface.
- 2 Vehicle  
Touch to enter the Vehicle Setting interface.
- 3 Settings

Touch to enter the Setting interface.

#### 4 Apple CarPlay

Touch to enter the Apple CarPlay interface.

#### 5 Navigation (only for high-line)

Touch to enter the Navigation interface.

#### 6 Picture

Touch to enter the Picture interface.

#### 7 Video

Touch to enter the Video interface.

#### 8 Phone

Touch to enter the Bluetooth Phone interface.

## **Power On/Off**

### **Power On**

Short press the power button to start the system.

If the vehicle power is turned off with the system currently in playback mode, the system will be automatically powered on when the vehicle power is turned on again.

If the vehicle power is turned off with the system in the Off state, short press the Power button on the system control panel to power-on the system after the vehicle power is turned on again.

With the system ON, long press the Power button on the system control panel for a period greater than 10 seconds, and the system will be automatically restarted.

### **Power Off**

With the system operating, short press the power button to switch the system off.

Turn off the vehicle power, and the system is automatically powered off.

# AIR CONDITIONING AND AUDIO SYSTEMS

---

After the ignition switch is turned off, press the On/Off button to turn on the entertainment system, the system will be automatically powered off after 30 minutes.

## **Standby Mode**

Short press the Power button to allow the entertainment system to enter the standby mode, the operation of the system will be suspended.

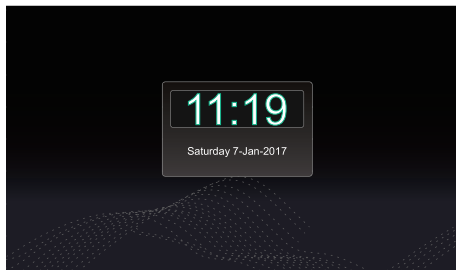

In the standby mode, all sounds will be muted, and the panel buttons can not be used for other operations. To cancel the standby mode, press the Power button again.

The standby mode can also be cancelled by the following operations:

- The system automatically skips to the reverse screen during parking.

## AIR CONDITIONING AND AUDIO SYSTEMS

- Turn off the vehicle power, and the system is directly powered off.

### Steering Wheel Control Buttons

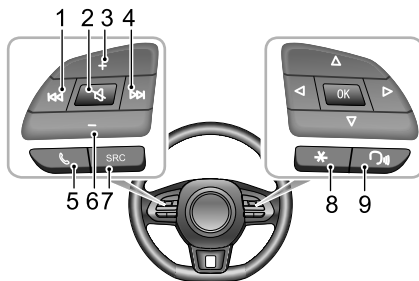

- I **⏮**: When playing audio, short press to return to the beginning of the track (except the Bluetooth music mode), short press again to switch to previous track, and long press to rewind (except the Bluetooth music mode). When playing video, short press to switch to previous video, and long press to rewind. When playing the radio, short press to switch to previous station; long press to search and play the previous station; long press continuously, the system will search

# AIR CONDITIONING AND AUDIO SYSTEMS

---

through a cycle, then stop at the current station and continue to play it.

2 : Mute/Cancel Mute

3 Volume Up Button

4 : When playing an audio/video, short press to switch to next track/video (except the Bluetooth music mode), and long press to fast forward. When playing the radio, short press to switch to next station; long press to search and play the next station; long press continuously, the system will search through a cycle, then stop at the current station and continue to play it.

5 : Long press to hang up if in calling/talking state; short press to answer and long press to reject if in incoming call state.

6 Volume Down Button

7 SRC Button

Switch to next available media audio.

8 Steering Wheel “\*” Button

The steering wheel “\*” button can be set as the shortcut key to CarPlay/Vehicle Setting/Main Interface.

9 SIRI Button

Activate/Cancel SIRI function. This button will only be used after Apple CarPlay is enabled.

## Volume Adjustment

- You can adjust the volume of different audio functions via the volume knob and steering wheel buttons. During the volume adjustment, the system will automatically display a pop up volume indication window, this will display the current volume setting, and change in accordance with control request. If no volume adjustment is detected for 3 seconds or other operations (e.g., pressing the panel button, touching the screen) are performed, the volume indication window automatically disappears.
- The system start up volume can be adjusted through [Setting] in the main interface. Refer to "Setting" in this chapter for details.

**Note:** *The volume adjustment knob and steering wheel buttons can only adjust the volume in media and communication functions.*

**Note:** *The playback volume of Bluetooth audios can be adjusted through the devices themselves as well as the entertainment player.*

## Connecting/Disconnecting a USB Storage Device

### Inserting a USB Storage Device

The USB port is located at the front of the centre console, insert a USB device into the USB port for connection.

### Removing the USB Storage Device

Check and confirm that there is no data being accessed, then pull out the USB storage device.

**Note:** *Some USB storage devices may be unidentifiable.*

**Note:** *The entertainment device may not achieve optimum performance when some USB storage devices are used.*

**Note:** *Connection via a USB hub is not allowed.*

# AIR CONDITIONING AND AUDIO SYSTEMS

---

## Bluetooth Phone

### Instructions

- Connection to all mobile phones featuring Bluetooth wireless technology is not guaranteed.
  - The mobile phone that you use must be compatible with the entertainment system so that all functions of Bluetooth phone of the system can function correctly.
  - When using Bluetooth wireless technology, this entertainment system may not be able to operate all functions on the mobile phone.
  - When transmitting voice and data via Bluetooth technology, the straight-line distance between this entertainment system and the mobile phone should not exceed 10 metres. However, the actual transmission distance may be shorter than the estimated distance, depending on the usage environment.
  - If Private mode is selected on the mobile phone, hands-free call function may be disabled.
  - When the entertainment system is turned off, the Bluetooth connection will also be disconnected.
- After the system restarts, the system will automatically attempt to reconnect the previously-connected mobile phone. If the connection is terminated for some reason, the system will automatically reconnect the specific mobile phone (except when the connection is terminated due to mobile phone operation).
  - Due to Bluetooth wireless connection interruption or error occurring in the process of transmission in some extreme conditions, the entertainment system may not be able to be paired and connected with a mobile phone. At this time, it is recommended to clear the paired devices in the mobile phone and the device list on the entertainment system, and perform pairing again.



# AIR CONDITIONING AND AUDIO SYSTEMS



2

## Bluetooth Pairing and Connection

Includes Bluetooth On and Off, device name, pairing code, Bluetooth state, etc.

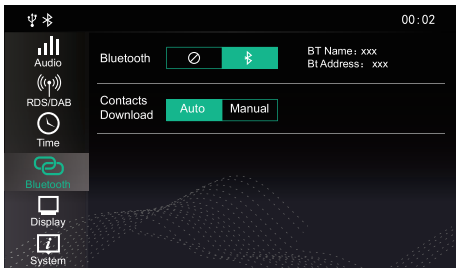
- Touch [Bluetooth] under [Setting] in the main interface, and enter the Bluetooth Setting interface. Touch  to open the Bluetooth function.



- System will display device name and Bluetooth address.
- When Bluetooth is not turned on, the status bar does not display Bluetooth icon. When Bluetooth is turned on but no device is connected, the status bar displays . When Bluetooth is turned on and a device is connected, the status bar displays .

## Pairing from Mobile Phone

Turn on the system Bluetooth function, request the connection from mobile phone end for pairing with the mobile phone.

- 1 Turn on the Bluetooth function on the mobile phone and search the entertainment system for pairing.

# AIR CONDITIONING AND AUDIO SYSTEMS

- If the mobile phone asks you to enter the pairing code, enter the pairing code set in the entertainment system.

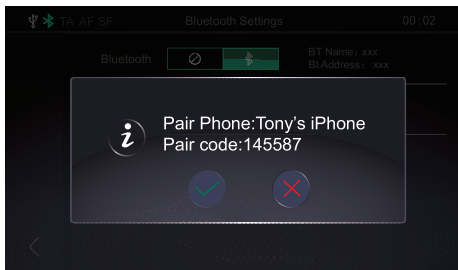



- After the pairing is completed, the message prompting connection completion appears. If the pairing fails, please repeat the procedure described above.

## Search a Device

If the Bluetooth function is switched on but not connected to a specific mobile phone, the system searches for available devices nearby which feature Bluetooth technology and are ready to connect, after the devices

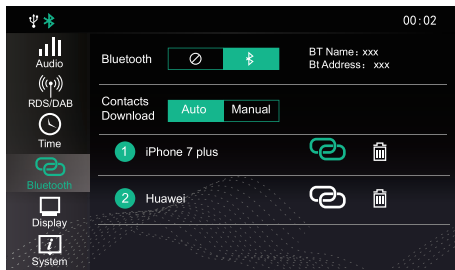
are found, they are displayed in the list. The system will connect to the mobile device that was last connected.



Touch  to connect the mobile phone Bluetooth, and touch  to disconnect the Bluetooth.

# AIR CONDITIONING AND AUDIO SYSTEMS

## Phone Menu

Touch the Bluetooth Phone area (the mobile phone Bluetooth is connected by default, and the mobile phone name or type will be displayed) in the main interface to enter the Bluetooth Phone menu, including Keypad, Contacts, Call History and Bluetooth.

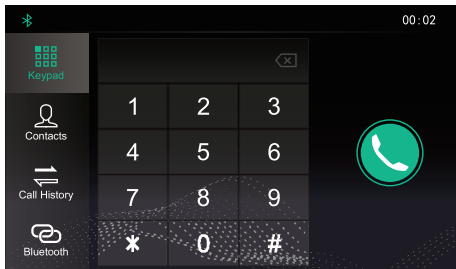

## Keypad

Touch Phone area in the main interface to enter the Dial Pad input interface.

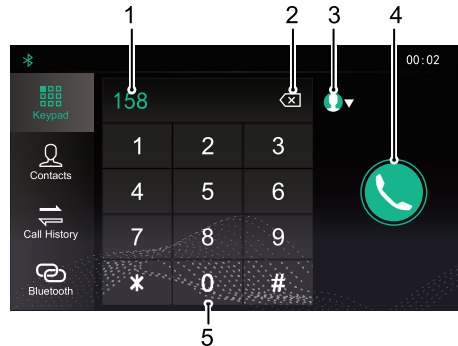

### 1 Input Box

You can input the phone number to be dialed.

### 2 Backspace/Delete Button

### 3 Matching a Contact

2

# AIR CONDITIONING AND AUDIO SYSTEMS

Input first three digits of the phone number, the system will match the number with any contacts that match the inputted numbers stored in the Contacts immediately. Touch  to retract the matching results or select the desired contact from the list displayed.

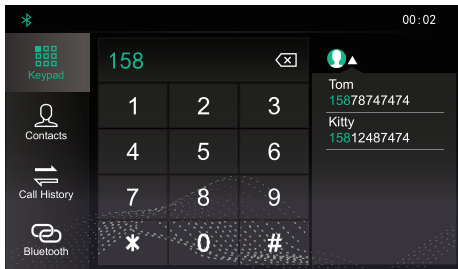

- 4 Making a Call
- 5 Input Keypad Area  
Input figures and symbols.

## Contacts

Touch Phone area in the main interface, and then touch [Contacts] to enter the Contacts interface.

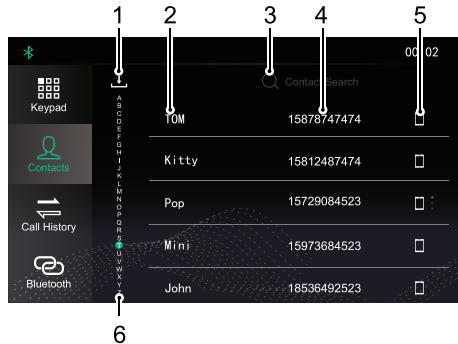

- 1 Download the Contacts
- 2 Contact Name
- 3 Search a Contact
- 4 Phone Numbers

# AIR CONDITIONING AND AUDIO SYSTEMS

## 5 Phone Numbers Type

Office Phone:  Home Phone:  Mobile Phone: .

## 6 Quickly Search a Contact

## Call History

Touch phone area in the main interface, and then touch [Call History] to enter the Call History interface.

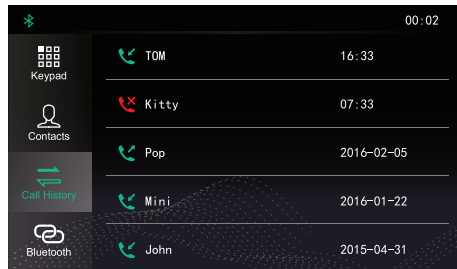

### 1 Call History Type

Dialled Calls: 

Received Calls: 

Missed Calls: 

### 2 Contact Name

### 3 Talk Time

# AIR CONDITIONING AND AUDIO SYSTEMS

Call history list is arranged by time and date in reverse chronological order.

## Bluetooth

Touch [Bluetooth] to enter Bluetooth connection interface. Refer to "Bluetooth Pairing and Connection" section for details.

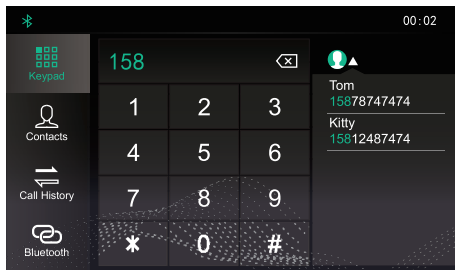

## Making a Call

### Dial Pad Input



- I Enter the Dial Pad Input interface to enter the phone number in the text box.

## AIR CONDITIONING AND AUDIO SYSTEMS

- 2 In the case of input error, touch , the input number figures will be deleted one by one. Long press the button to delete all figures.
- 3 Input first three digits of the phone number, the system will match the number with any contacts that match the inputted numbers stored in the Contacts immediately. Touch  to retract the matching results or select the desired contact from the list displayed.

- 5 Touch  to end the call.

2

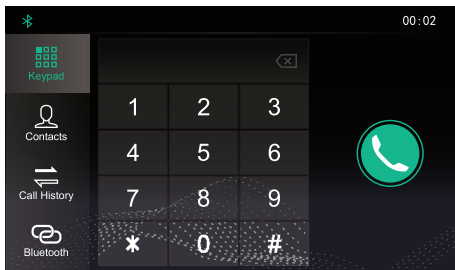

- 4 Touch  and make a phone call through Bluetooth.

# AIR CONDITIONING AND AUDIO SYSTEMS

## Calling from Call History

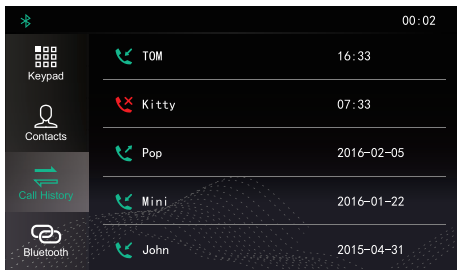

- 1 Enter Phone area in the main interface, and then touch [Call History] to enter the Call History interface.
- 2 Touch a certain Call History record in the list to call the contact.

## Making a Call in the Contacts

Enter Phone area in the main interface, and then touch [Contacts] to enter the Contacts interface.

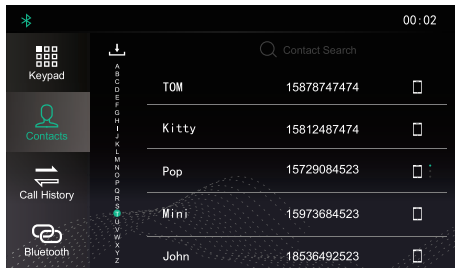

## Download the Contacts

When the entertainment system and mobile phone Bluetooth are connected, the system will automatically download the contacts in the mobile phone into the system. To prevent this from happening, use the Auto/Manual selection button on the Bluetooth homepage and set to Manual.



# AIR CONDITIONING AND AUDIO SYSTEMS

2

In the Contacts interface, click  to download the contacts manually.

Enter Bluetooth phone interface, and then touch [Contacts]. The contacts in the mobile phone will appear.

The contacts synchronized via Bluetooth support quick search calling, it does not support deleting contacts.

**Note:** For some mobile phones, a dialog box asking whether to synchronise the phone book will pop up before synchronisation of contacts.

**Note:** Since the system temporarily does not support some commercially available mobile phones, the case of no synchronisation of Bluetooth phone book will occur on non supported phones.

**Note:** New contacts that are added will not be displayed until the next synchronisation is carried out.

## Quick Search

Touch a letter at the left side of the contacts interface or slide the highlighted area to quickly locate the contacts with this letter as the initial letter.

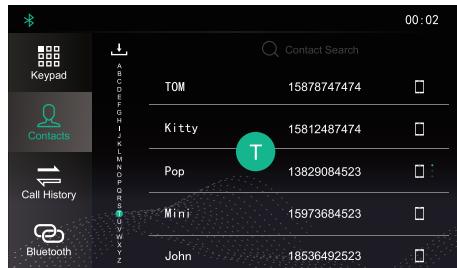

Touch the contact search area on the interface, input the initial letter of the name to be searched or input the name to search, the filtered list of contacts will be displayed, then touch and call the contact.

# AIR CONDITIONING AND AUDIO SYSTEMS

## Calling the Entry in “Contacts”

Directly touch the contact list in [Contacts] interface to make a call.

When a contact person has multiple contacts, click the phone numbers type icon to select the phone number, and then make a call.

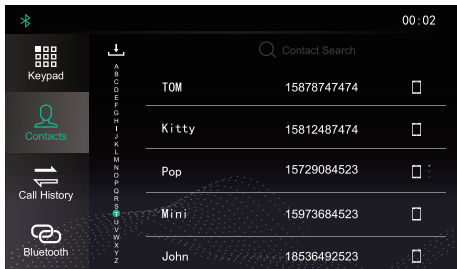

## Incoming Call

### Answer an Incoming Call

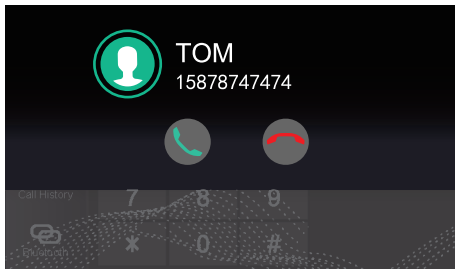

- When there is an incoming call, touch  to answer the call.



- If there is an incoming call, short press  button on the steering wheel to answer the call.
- You may also select to answer the call with your mobile phone.

# AIR CONDITIONING AND AUDIO SYSTEMS

## Reject an Incoming Call

- In the main system interface or full screen mode of an incoming call, touch  to reject the call.
- If there is an incoming call, long press  button on the steering wheel to reject the call.
- You may also select to reject the call with your mobile phone.

## Switch to Private Mode

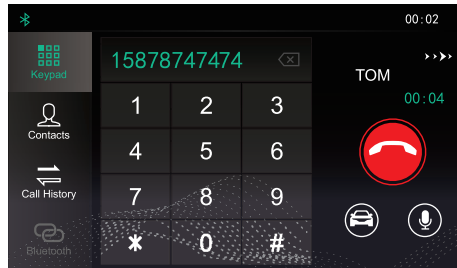

During the call, touch  to enter Private Mode (defaults to Speaker Mode).

During the call, touch  button to restore the Speaker Mode.

During the call, touch  to switch between the microphone mute or enable function.

In Private Mode, you may continue with the call with your mobile phone; the speakers and microphone of

# AIR CONDITIONING AND AUDIO SYSTEMS

---

the entertainment system will be muted. But the pair connection via Bluetooth wireless technology will remain.

## Adjust In-call Volume

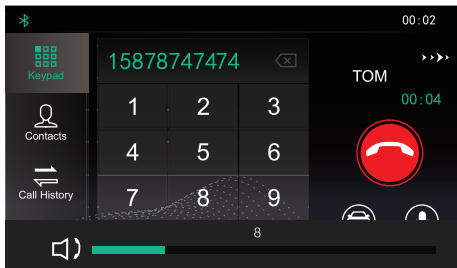

During a call, rotate the volume adjustment knob or press the volume adjustment button in the steering wheel controls to adjust the in-call volume.

## Entertainment

### Instructions

- USB port can offer mobile phone charging, U disc music and Apple CarPlay.

### Precautions for Playback Storage Media Mode

- This system supports U disc and Bluetooth storage media.
- If the USB device media is not in use, DO NOT leave the device connected. This may result in connection deterioration.
- Do not remove USB device whilst media is playing. Failure to follow these instructions could result in corrupted data.
- Keep the USB port dry and free from debris. The port will become unusable if it is blocked.

# AIR CONDITIONING AND AUDIO SYSTEMS

## USB Music

Insert a USB storage device into the USB port, and the system will automatically load the music on the storage device.

Touch the Radio/Music area in the main interface, and then touch [USB Music] to enter the USB Music Playback interface.

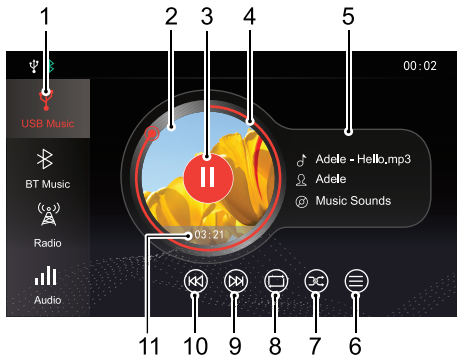

I Music Playback Media Switching

You may select USB music or Bluetooth music.

### 2 Album Cover

The album cover of currently playing track (if stored on the media device).

### 3 Play/Pause

Play/Pause the current track.

### 4 Track Playback Progress Bar

Track playback progress is displayed by the red coil, drag the progress bar to skip to certain playing point.

### 5 Artist Name (if stored on the media device)

### 6 USB Music List

Touch to enter the corresponding folder list interface, then touch to select and play the track you prefer.

# AIR CONDITIONING AND AUDIO SYSTEMS

---

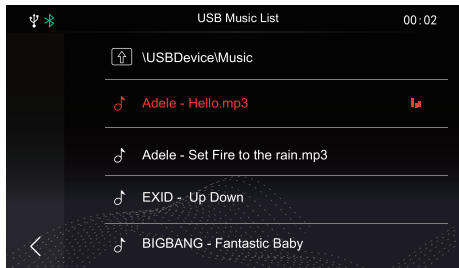

Short press to switch to the previous track; short press during playback to return to the beginning of the track; long press to rewind.

## 11 Current Elapsed Time

Song playback progress is displayed.

In this interface, touch [Audio], the system will skip to Sound Setting interface. Refer to "Sound Setting" in "Setting" section for details.

## 7 Random Playback Mode

You may switch between Random Playback, Folder Random Playback and Random Playback Off.

## 8 Loop Playback Mode

You may switch between Single Loop, Folder Loop and Loop All and Loop Off.

## 9 Next Track

Short press to switch to the next track; long press to fast forward.

## 10 Previous Track

# AIR CONDITIONING AND AUDIO SYSTEMS

2

## Bluetooth Music

Please connect a Bluetooth device first before playing Bluetooth music. Refer to "Bluetooth Pairing and Connection" in "Bluetooth Phone" section for details.

After the Bluetooth device is connected with the system, touch the Radio/Music area in the main interface, and then touch [Bluetooth Music] to enter the Bluetooth Music playback interface.

- 1 Play/Pause
- 2 Artist Name
- 3 Next Track
- 4 Previous Track

In this interface, touch [Audio], the system will skip to Sound Setting interface. Refer to "Sound Setting" in "Setting" section for details.

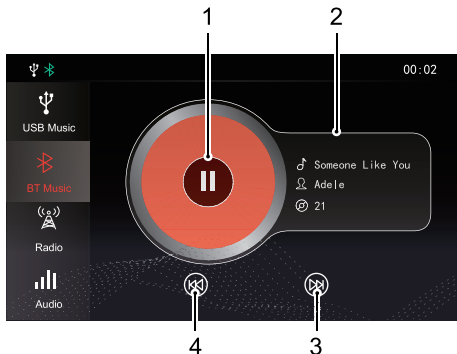

# AIR CONDITIONING AND AUDIO SYSTEMS

## Radio

Touch the Radio/Music area in the main interface, and then touch [Radio] to enter the radio interface.

To listen to the broadcasting of different bands, touch [FM], [AM] or [DAB] in the playback interface to switch between radio bands and DAB. Pressing the SRC button can also switch between the different radio bands.

## FM/AM

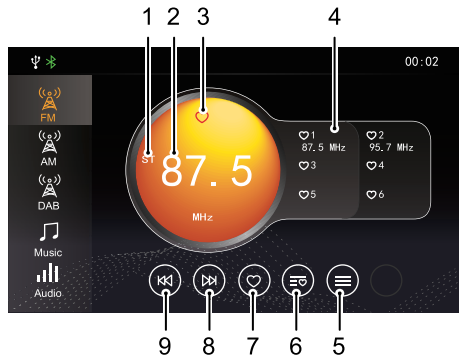

### 1 Stereo Icon

The stereo broadcasting station will display this icon.

### 2 Current Station Name or Frequency

Touch [FM], [AM] or [DAB] to switch the band.

### 3 Station Favorites State



# AIR CONDITIONING AND AUDIO SYSTEMS

 indicates that the station has been added to Favorites; if no such icon, it indicates that the station is not included in your Favorites.

## 4 List of Favorite Stations

## 5 Station List

Touch to enter station list, touch [Update] to search the station, and store the searched station into the station list.

## 6 Station Favorites List

## 7 Add a Station to Favorites

## 8 Next Station

Short press to automatically search for the next station; long press to manually search for the next station.

## 9 Previous Station

Short press to automatically search for the previous station; long press to manually search for the previous station.

## DAB

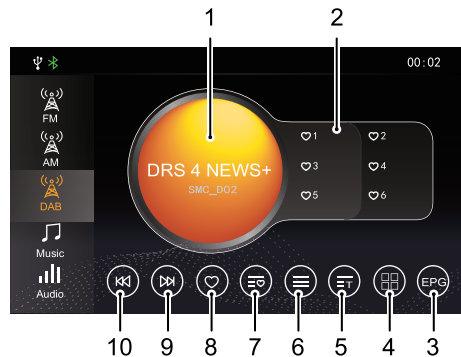

## 1 Current Station Name or Frequency

Touch [FM], [AM] or [DAB] to switch the band.

## 2 List of Favorite Stations

## 3 Electronic Program Guide

## 4 DAB Categories List

# AIR CONDITIONING AND AUDIO SYSTEMS

---

## 5 Radio information

Touching the button will display radio information, such as text, picture.

## 6 Station List

## 7 Station Favorites List

## 8 Add a Station to Favorites

## 9 Next Station

Short press to automatically search for the next station; long press to manually search for the next station.

## 10 Previous Station

Short press to automatically search for the previous station; long press to manually search for the previous station.

## Video

This system supports WMV, H264, MPEG2, MPEG4 and HD Video Playback video files.

Insert a USB storage device into the USB port, and the system will automatically load the videos on the storage device.

**Note: Due to differences in the compression ratio and bit rate of the multimedia formats downloaded from the Internet and other factors, it may not be possible to decode and play all files, the quality may vary.**

**Note: For your driving safety, when the vehicle speed is greater than 10 mph (15 km/h), the video safety mode will be activated automatically, and the video cannot be played at the moment.**

**Note: The video cannot be played during a call.**

Touch [Video] in the main interface to enter video application interface.

**Note: When playing a video, click the screen to display the menu bar mode, and click it again to exit menu bar mode.**

# AIR CONDITIONING AND AUDIO SYSTEMS

2



1 Current Elapsed Time

2 Previous Video

Short press to switch to previous video; long press to fast rewind.

3 Playback Progress Bar

Drag the progress bar forward or backward to directly return or skip to certain playing point.

4 Play/Pause

5 Next Video

Short press to switch to next video; long press to fast forward.

6 Video List

The corresponding video file can be viewed and played; the video file displayed in the folder can also be viewed and played.

7 Total Video Duration

# AIR CONDITIONING AND AUDIO SYSTEMS

## Picture

Insert a USB storage device into the USB port, and the system will automatically load the pictures on the storage device.

Touch [Picture] in the main interface to enter picture application interface.

Touch picture file to display the picture in full screen.

When viewing pictures, click the screen to display the menu bar mode, and click it again to exit menu bar mode.

## Picture Browsing Interface



### 1 Slide Show

Automatically cycles through and displays pictures in the folder.

### 2 Zoom In

### 3 Zoom Out

### 4 Thumbnail

### 5 Picture List

The corresponding picture file can be viewed and included in the Slide Show function; the picture file displayed in the folder can also be viewed and included in the Slide Show function.

**Note:** *The system supports the viewing of pictures stored on a USB device. Due to differences in picture resolution, format compression ratio and some other factors not all pictures may be decoded and displayed.*

**Note:** *Swipe to the left or right on the screen to switch to the next or previous picture.*

### Apple CarPlay

The Apple CarPlay can realise bilateral control of a mobile phone and the onboard entertainment system, so that the mobile phone can be controlled via the onboard entertainment system, including answering/making a call, listening to music stored on the mobile phone, etc., and direct operation through the mobile phone is also possible, which provides the owner with an infinite interconnection between vehicle and mobile phone.

This function can realise the interconnection between iPhone functions (Map, Music, Phone Call, Short Message, Podcast, Voice Recognition, etc) and the on-board entertainment system.

**Note:** *Owing to the difference in mobile phone models and software versions, the presented interfaces may be inconsistent with those shown on your mobile phone; therefore, the attached figures are for reference only.*

# AIR CONDITIONING AND AUDIO SYSTEMS

## Connection Method

- 1 Make sure that the CarPlay function of mobile phone is turned on.
- 2 Use an approved USB connecting cable to connect the mobile phone to the on-board entertainment system.
- 3 Touch CarPlay area in the main interface to activate CarPlay.
- 4 After the vehicle and mobile phone are successfully connected, you can operate the iPhone on the system mainframe.
- 5 Press the return key on the control panel or touch  button to return to the main system interface.

## Operation methods of Apple CarPlay

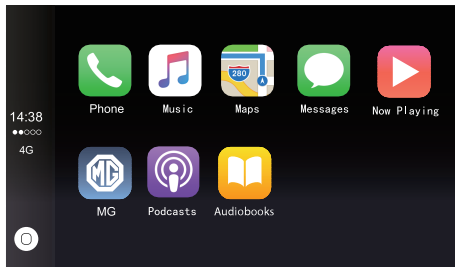

The user can control the Apple CarPlay system through three methods as follows:

- 1 Conduct voice control with Siri.
- 2 Using the onboard touchscreen.
- 3 Using the physical buttons on the control panel and steering wheel.

# AIR CONDITIONING AND AUDIO SYSTEMS

## Phone Call using Apple CarPlay

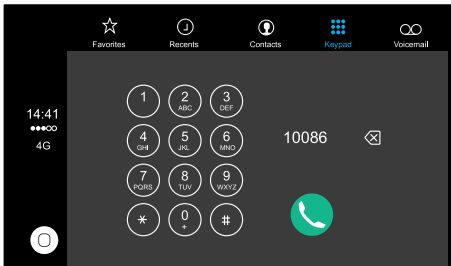

After the Apple CarPlay function is connected correctly, the phone call function of Apple CarPlay can be used on the on-board entertainment system.

- 1 Make a call with the dial pad.
- 2 View contacts or make a call through the contact list.
- 3 View the call history or make a call through the call history.
- 4 Answer a call.
- 5 Check voice message.

## Music using Apple CarPlay

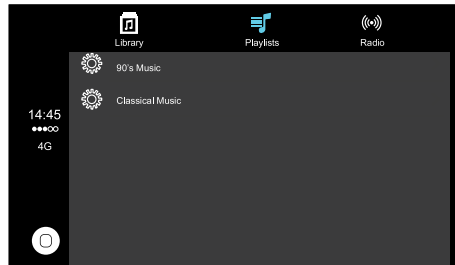

By clicking the Icon [Music] in the Apple CarPlay system, the music function of Apple CarPlay can be accessed via the on-board entertainment system.

# AIR CONDITIONING AND AUDIO SYSTEMS

## Map using Apple CarPlay

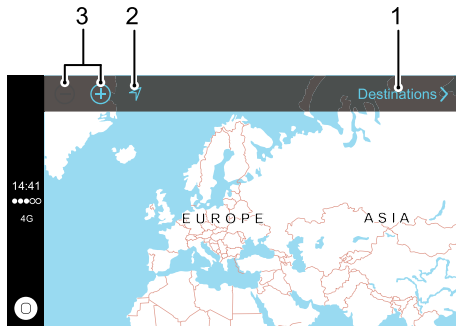

By clicking the Icon [Map] in the Apple CarPlay system, you can use the map function of Apple CarPlay on the on-board entertainment system.

- 1 Destination search.

The map search history will be recorded and can be viewed by clicking the Icon [Destination].

- 2 Navigation to destination.

- 3 Map zooming.

## Messages using Apple CarPlay

By clicking the Icon [Message] in the Apple CarPlay system, you can use the message function of Apple CarPlay on the on-board entertainment system.

- 1 Vocally input recipient, message content and send;
- 2 Send a voice message.

## Apple CarPlay Siri

Use Siri Voice Assistant to realise the following functions:

- 1 Make a Call.
- 2 Send a message.
- 3 Play music.
- 4 I want to go to XXX (to activate the navigation).
- 5 What time is it now?
- 6 What's the weather like today?
- 7 Set a reminder.



## Third-party Applications of Apple CarPlay

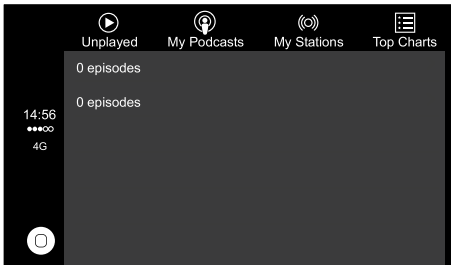

Apple CarPlay also supports Podcast, Audiobook, iHeartRadio, AtBat and other third-party applications. Refer to the operating instructions of corresponding software for specific operation method.

## Vehicle Settings

With the ignition switch in the ON position, touch [Vehicle] in the main interface to enter the Vehicle Settings interface.

## Comfort and Convenience

After entering the Comfort and Convenience interface in the Vehicle Settings, [Lighting] and [Other] can be set.

## Lighting

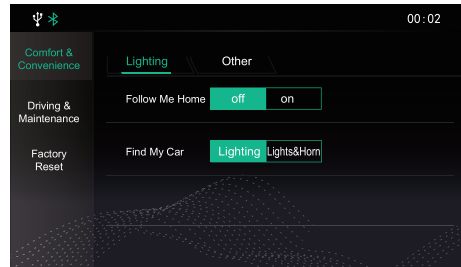

# AIR CONDITIONING AND AUDIO SYSTEMS

- Follow Me Home: Select to turn on/off Follow Me Home function as required.
- Find My Car: Set the way in which the car can be identified: [Lighting] or [Lights & Horn].

## Other

In the [Lighting] interface, touch [Other] to set function of the “\*” button on the steering wheel.

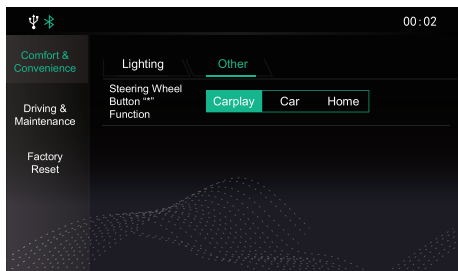

The steering wheel “\*” button can be set as the shortcut key of [Carplay], [Car] or [Home].

## Driving and Maintenance

In the Vehicle Settings interface, touch [Driving and Maintenance] to enter the Driving and Maintenance Settings interface.

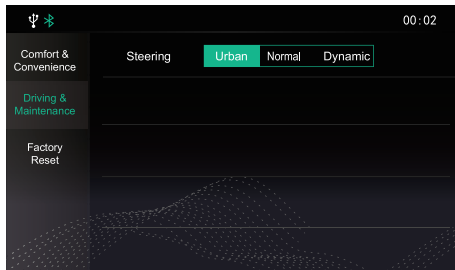

- The level of power steering assistance can be set as [Urban], [Normal] or [Dynamic].

## Factory Reset

In the Vehicle Settings interface, touch [Factory Reset] to enter Restore Factory Settings interface.

# AIR CONDITIONING AND AUDIO SYSTEMS

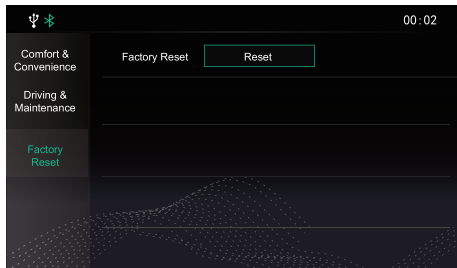

Touch [Reset] in the Factory Settings interface, the on-board entertainment system will be reset to its original settings and all data in the Vehicle Settings system will be deleted. Please use with caution.

## A/C Display \*





For vehicles equipped with automatic A/C, when adjusting A/C, the status bar will automatically pop up at the bottom of the main interface.



1 Air Conditioning On/Off Display

2 Temperature Display

3 Air Distribution Mode Display

-  To "Face".
-  To "Face" + "Foot well".
-  To "Footwell".
-  To "Footwell"+ "Defrost".

4 Blower Speed Display

5 Air External Circulation Mode Display:  External Circulation

6 Air Internal Circulation Mode Display:  Internal Circulation

# AIR CONDITIONING AND AUDIO SYSTEMS

## Settings

### Volume Setting

Touch the setting area in the main interface to enter the Volume Setting interface.

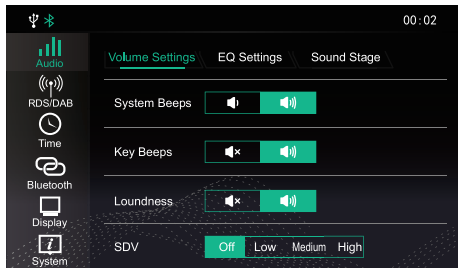

- System Prompt Tone

Touch to adjust system prompt tone volume.

- Keypad Tone

Touch to turn on/off keypad tone.

- Loudness Compensation

When enabled this will help compensate for deficiencies in the bass and treble ranges at low volume.

- Speed Volume Control (SVC)

The speed volume has 3 levels: low, medium and high. Select as required, or turn it off.

# AIR CONDITIONING AND AUDIO SYSTEMS

## EQ Setting

Touch [EQ Setting] to enter EQ Setting interface. You are able to choose between 6 preset equaliser levels to suit your own preference.

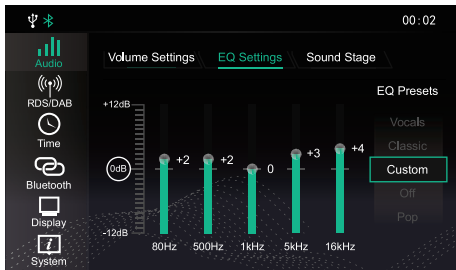

The preset EQ has 6 options: Classic, Pop, Jazz, Vocal, Rock, and Custom.

Touch and drag the marker  to customize the EQ parameters.

When the value of any band of the EQ is being changed, custom is automatically highlighted, which indicates that it

is selected. When exiting the EQ setting, the setting will be automatically saved.

**Note:** *The EQ setting only works on media-type audios, so please use volume knob or steering wheel buttons to adjust the volume of other audios.*

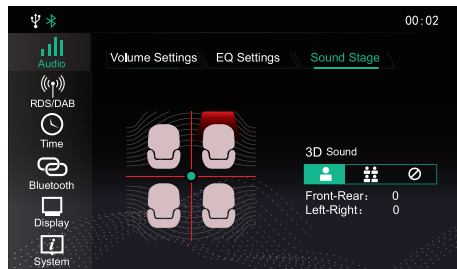

## Sound Stage Setting

Touch [Sound Stage] to enter Sound Stage interface. You can choose a balance setting that provides an ideal listening environment in all occupied seats.



Touch  to adjust the central position of sound field.

# AIR CONDITIONING AND AUDIO SYSTEMS

Touch    to select single or multiple mode, or cancel 3D sound field mode.

## RDS DAB Setting

In the settings interface, touch [RDS/DAB], and enter the RDS/DAB settings interface.

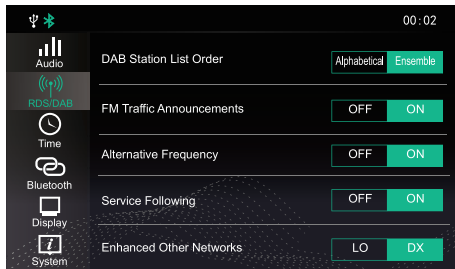

- Touch [DAB Station List Order] to select the way in which the station list is sorted and displayed.  
Touch [by Ensemble] to sort the station list by ensemble name and then stations in alphabetical order.  
Touch [by Station] to display the station list in alphabetical order.
- Touch [FM Traffic Announcements] to turn on/off the TA function.

# AIR CONDITIONING AND AUDIO SYSTEMS

Selecting TA [On] allows the system to analyse and communicate traffic messages to the driver. This information may be in the form of voice messages.

Select [Off] to inhibit traffic announcements.

- Touch [Alternative Frequency] to turn on/off the AF function.

AF is alternative frequency, when the signal is below a certain level, AF will automatic search for an alternative frequency of the current station if the current station supports this function.

- Touch [Service Following] to turn on/off the Service following function.

Service Following is the term applied to maintaining the same audio or data content that the user has selected in varying reception conditions if the current station supports this function.

- Touch [Enhanced Other Networks], you can select LO or DX states.

EON - Enhanced Other Networks enables the system to obtain information from other networks as well

as the one selected. Select LO for Local or DX for networks further afield.

- Touch [Regional] to turn on/off the Regional tracking mode function.
- Touch [DAB Announcements], there are 11 Announcements types to choose from.

Touch the check box to select.

## Time and Date Setting

In the setting interface, touch [Time] to enter the Time and Date Setting interface.

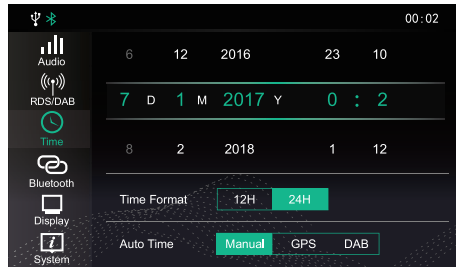

# AIR CONDITIONING AND AUDIO SYSTEMS

## **Date and Time Setting**

Move the corresponding number up or down to set the system time. The set time will be synchronised with, and displayed in the information centre of instrument pack.

### **Time Format**

You can select 12-hour format or 24-hour format according to your preference.

### **Auto Time**

You can select the method by which the time is updated [Auto Time] via GPS, DAB or Manual according to your preference.

### **Daylight Saving Time**

You can turn on/off the function of Daylight Saving Time according to your preference.

## **Connection Setting**

Touch [Bluetooth] to enter the Bluetooth Switch interface. For details refer to "Bluetooth Phone" in this section.

## **Display Setting**

Touch [Display] to enter the Display Setting interface, you are able to adjust the display to your personal preference.

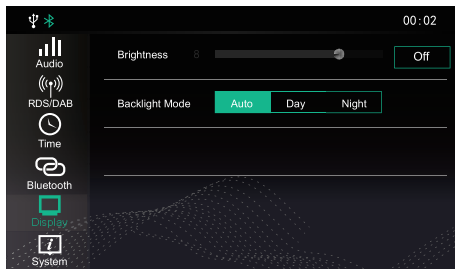

### **Brightness**

When the brightness mode is [Day] or [Night], touch and drag the cursor to adjust the backlight brightness of the



screen. When the brightness mode is [Auto], the system will display the default brightness value.

## **Backlight Mode**

You can choose [Auto], [Day] or [Night] mode to adjust the screen brightness as required.

## **System Settings**

Touch [System] on the Setting interface to enter the System Settings interface, where you can view software/hardware levels and set some basic states and functions of the system.

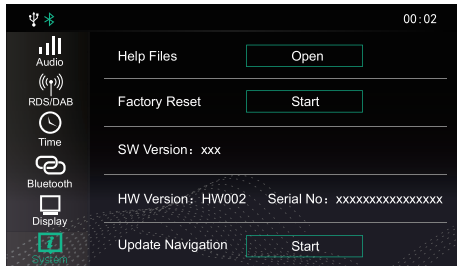

## **Help Files**

Touch [Open], to view the brief operating instructions of the system.

## **Factory Reset**

Touch [Start] to enter Restore Factory Settings interface, and restore [All], [Audio Setting], [Station Storage] and [Others] to default factory settings as required. A dialog box will be displayed asking "Are you sure to restore factory settings?".

After restoring factory settings, the on-board entertainment system is reset to its original settings and all data in the entertainment system will be deleted. Please use with caution.

In the [System] interface, you can view [Software version], [Hardware version], [Serial No] and other data.

On models fitted with navigation you are able to perform navigation updates.



## **Seats & Restraints**

---

*124 Seats*

*128 Seat Belts*

*137 Airbag Supplementary Restraint  
System*

*146 Child Restraints*

# SEATS & RESTRAINTS

---

## Seats

### Overview



***To avoid personal injuries due to the loss of control, DO NOT adjust the seats while the car is moving.***

The vehicle is equipped with 6-direction or 4-direction adjustable front seats and 60/40 split rear seats with foldable backrests.

An ideal position of the seat should make sure your driving position is comfortable, which allows you to hold the steering wheel with your arms and legs slightly bent and control all the equipment. Make sure your driving position is comfortable and enables you to maintain full control of the vehicle. Take care when adjusting the height of front seats - the feet of the rear passenger could become trapped when the seat is lowered.

Do not incline the front-seat backrest excessively. Optimum benefit is obtained from the seat belt with the backrest angle set to approximately 25° from the upright (vertical). The driver and front passenger seats should

be positioned as far rearward as practical. A properly adjusted seat helps reduce the risk of injury from sitting too close to an inflating airbag.

### Head Restraints



*Adjust the height of the head restraint so that the top of it is in line with the top of the occupant's head. This location may reduce the risk of head and neck injuries in the event of a collision. DO NOT adjust or remove the head restraints while the car is moving.*



*DO NOT hang anything on any head restraint or head restraint rod.*

The head restraint is designed to prevent rearward movement of the head in the event of a collision or emergency braking, thereby reducing the risk of head and neck injuries.

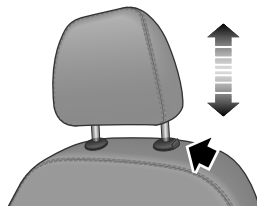

3

When adjusting a head restraint from low to high position, pull the head restraint directly upward, and gently press it downward after it reaches the desired position to make sure that it is locked in position. To remove the head restraint, press and hold the guide sleeve button (as indicated by the arrow) on the left of the head restraint, then pull the head restraint upward to remove it.

When adjusting a head restraint from high to low position, press the guide sleeve button (as indicated by the arrow) on the left of the head restraint, and press the head restraint downward; release the button after it reaches the desired position, and gently press the head restraint downward to make sure that it is locked in position.

# SEATS & RESTRAINTS

---

## Manual Adjustment of Seats

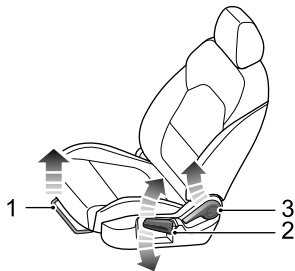

- Forward/Backward Adjustment

Lift the lever (1) under the seat cushion, slide the seat into an appropriate position and release the lever. Make sure that the seat is locked in place.

- Cushion Height Adjustment \*

Lift the lever (2) repeatedly to raise the seat cushion, and press the lever downward to lower the seat cushion.

- Backrest Adjustment

Lift the lever (3), adjust the backrest until it moves into a satisfiable position , and put down the lever.

### Rear Seats



### Folding Rear Seats

To increase luggage space, first fully lower (or remove) all the rear seat head restraints, and then pull up the backrest unlock straps on both sides respectively and fold the seat backrests forward.

**Note:** When the head restraint of the rear seat is not fully lowered or the backrest of the front seat is

*inclined backward excessively, the folding of the rear seat is very likely to damage the back of the front seat, small storage compartment or head restraint of the rear seat.*

### Unfolding and Locking Rear Seat Backrests

When returning the rear seat backrest to the upright position, pull up the backrest unlock straps to release the locked state, push the backrest until it reaches an appropriate position, and the backrest is locked when you hear a click.

**Note:** When returning the rear seat backrest to the desired position, make sure that the rear seat belt is not trapped.

## SEATS & RESTRAINTS

---

### Seat Belts



*It is important that all seat belts are worn correctly. Always check that all passengers are wearing seat belts. DO NOT carry passengers that are unable to wear correctly positioned seat belts. Wearing seat belts incorrectly may cause serious injury or even death in the event of a collision.*



*Airbags can not replace seat belts. Airbags can only provide extra support when triggered, and not all traffic accidents will trigger airbags. Whether airbags are triggered or not, seat belts can reduce the risks of serious injury or death in accidents. Therefore, seat belts must be worn properly.*



*NEVER unfasten a seat belt whilst driving, serious injury or death may occur in the case of an accident or emergency braking.*



*NEVER fasten the driver seat belt or use a buckle replacement when the driver seat is vacant or when exiting the vehicle. This could cause the engine to restart automatically.*



This vehicle is equipped with seat belt warning lamp to remind you to fasten your seat belt.

During driving, seat belts must be fastened, this is because:

- You can never predict if you will be involved in a collision accident and how serious it may be.
- In many cases of collision accidents, passengers with seat belts properly fastened are well-protected, while passengers with seat belts not fastened suffer from serious injury or even death.

Therefore, all passengers must wear seat belts correctly, even during short-distance journeys.



### Protection Provided by Seat Belts



*It is of equal importance for passengers in the rear seat to fasten their seat belts correctly. Otherwise, passengers with seat belts not correctly fastened will be thrown forward in accidents, and will endanger themselves as well as the driver and other passengers.*

When the vehicle is in motion, the travelling speed of the occupants is identical to that of the vehicle.

In the event of a 'head on collision' or emergency braking, the vehicle may stop, but the occupants will carry on travelling until they come into contact with a stationary object. This object may be the steering wheel, dashboard, windscreen or front seats.

A correctly fastened seat belt will eliminate this risk of injury. When the seat belt is worn correctly, it will lock automatically in collision accidents or emergency braking to reduce your speed together with the vehicle, so as to prevent the out-of-control movement which may cause serious injury to driver and passengers.



## SEATS & RESTRAINTS

---

### Wearing Seat Belts



*Incorrectly worn seat belts could cause injury or death in the event of an accident.*



*Seat belts are designed for one person, DO NOT share seat belts.*



*DO NOT wrap a seat belt around when holding a baby or child in your arms.*



*Remove any heavy coats or clothing when wearing a seat belt, failure to do so can affect protection provided by the seat belt.*



*Seat belts should not be wrapped around hard or sharp objects such as pens, spectacles or keys.*



*Seat belts cannot function correctly when the seats are reclined excessively. DO NOT drive when the seats are excessively reclined.*

The seat belts fitted to your vehicle are designed for use by normal sized adults. This part of the literature refers to adult use.

All seat belts are 3 point lap-diagonal belts.

In order to maintain effective protection, the passengers must sit in the correct orientation, feet placed on the floor in front of them, with an upright body (no excessive recline) and the seat belt correctly fastened.

### Fastening Seat Belts

Please follow the instructions below to fasten the seat belts correctly.

- 1 Adjust the seat correctly.
- 2 Hold the metal tab, pull the seat belt out steadily over the shoulder and across your chest. Ensure there is no twist on the belt.

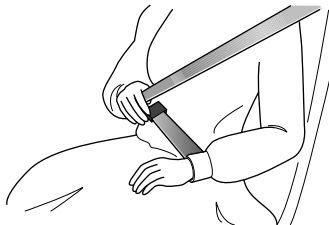

- 3 Insert the metal tab into the buckle until you hear a 'click', this indicates the seat belt is securely locked.

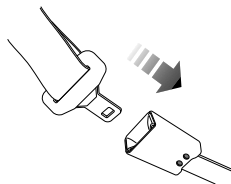

- 4 Remove any slackness in the belt by pulling up on the diagonal section of the belt.
- 5 To release the seat belt, press the red button on the buckle. The seat belt will retract automatically to its original place.

## SEATS & RESTRAINTS

### IMPORTANT

- Always ensure the seat belt will not become trapped in the door aperture when closing the door, damage will occur.
- Pulling the seat belt out too quickly may cause it to lock. In this case, allow the seat belt to retract slightly and then pull it across your body slowly.
- If it is difficult to pull the seat belt out, it may be due to twisted webbing. If this is the case, fully extract the seat belt, remove the twist, allow the seat belt to retract slowly.
- When using the rear seat belts please ensure they are fully retracted into the correct position to avoid jamming in the rear seat catches. It is a legal requirement to wear seat belts. Even if the seat belt is twisted it must be worn. Where possible avoid the twisted section contacting the body and seek advice from an MG Authorised Repairer as soon as possible.

### Correct Routing of the Seat Belts



**Ensure the seat belt is correctly positioned on the body, never cross the neck or abdomen, never pass the seat belt behind the back or under the arms.**

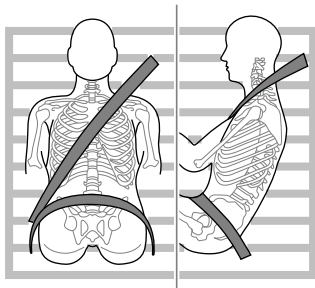

When wearing seat belts, the lap belt section should be positioned as low as possible across your hips, never across the abdomen. In the event of a collision, the lap belt can apply a force on the hips and reduce the possibility of you

slipping under the lap belt. If you slip under the lap belt, the belt will apply force on your abdomen, which may cause serious or fatal injuries. The diagonal section of the belt should cross the middle of the shoulder and the chest. In the event of emergency braking or collision, the diagonal section of the belt will be locked.

To ensure that the seat belts always provide maximum protection, ensure the belt is flat, not loose and contacts the body.

### **Seat Belts Use during Pregnancy**

Wearing correctly positioned seat belts will provide protection for both mother and unborn child in the event of a collision or emergency braking.



The diagonal section of the seat belt should pass across the chest as normal, the lap section of the belt should pass below the belly, low and snug on the hip bones. NEVER position the belt on or above the belly.

Please consult your physician for further details.

### **Seat Belts and Disabilities**

It is a legal requirement that all occupants wear seat belts, this include people with disabilities.

Depending upon the disability, consult your physician for further details.

## SEATS & RESTRAINTS

---

### Seat Belt Pre-tensioners



*The seat belt pre-tensioners will only be activated once and then **MUST BE REPLACED**. Failure to replace the pre-tensioners will reduce the efficiency of the vehicle's front restraint system.*



*If the pre-tensioners have been activated, the seat belts will still function as restraints, and must be worn in the event that the vehicle remains in a drivable condition. The seat belt pre tensioners should be replaced at the earliest opportunity by an MG Authorised Repairer.*

The vehicle is fitted with seat belt pre-tensioners, these are designed to retract the front seat belts and work in conjunction with the airbags in the event of a severe collision. They are designed to retract the seat belt and 'secure' the occupant in the seat.

The airbag warning light on the instrument pack will alert the driver to any malfunction of the seat belt

pretensioners.(see 'Warning Lamps and Indicators' in the 'Instruments and Controls' chapter).

The seat belt pre-tensioners can only be activated once, after activation they must be replaced. This may also involve replacement of other SRS components. Please refer to 'Replacing Airbag System Parts'.

#### IMPORTANT

- Seat belt pre-tensioners will not be activated by minor impacts.
- The removal or replacement of a pre-tensioner must be carried out by the manufacturer trained, dealer technicians.
- 10 years from the initial date of registration (or installation date of a replacement seat belt pre-tensioner), some components will need to be replaced. The appropriate page of the Warranty and Maintenance Manual must be signed and stamped once the work has been completed.

### Seat Belt Checks, Maintenance and Replacement

#### Seat Belt Checks



*Split, worn or frayed seat belts may not function correctly in the event of a collision, if there are any signs of damage, replace the belt immediately.*



*Always ensure the red release button on the seat belt buckle is pointing upwards to ensure easy release in the event of an emergency.*

Please follow the instructions below to regularly check whether the seat belt warning lamp, seat belt, metal tab, buckle, retractor and fixing device are working correctly:

- Insert the seat belt metal tab into the corresponding buckle and pull seat belt webbing close to the buckle quickly to check that the belt clasp locks.
- Hold the metal tab and pull the seat belt forward quickly to check that the seat belt reel locks automatically, preventing the webbing from extending.

- Fully extract the seat belt and visibly examine for twists, fraying, splits or worn areas.
- Fully extract the seat belt and allow to return slowly to ensure continual and complete smooth operation.
- Visibly examine the seat belt for missing or broken components.
- Ensure the seat belt warning system is fully functional.

If the seat belt fails any of the above tests or inspections contact an MG Authorised Repairer immediately for repairs.

#### Seat Belts Maintenance



*Seat belt repairs should only be carried out by an MG Authorised Repairer.*



*Ensure no foreign or sharp objects become lodged in the seat belt mechanisms. DO NOT allow liquids to contaminate the seat belt buckle, this could affect the buckle engagement.*

## SEATS & RESTRAINTS

---

Seat belts should only be cleaned with warm soapy water. Do not use any solvent to clean the seat belt. Do not attempt to bleach or dye the seat belt, it may weaken the seat belt. After cleaning, wipe with a cloth and allow to dry. Do not allow the seat belt to fully retract before it is completely dry. Keep seat belts clean and dry.

If there are contaminants accumulated in the retractor, the retraction of the seat belt will be slow. Please use a clean and dry cloth to remove any contaminants.

### Replacing Seat Belts



***Collision accidents may damage the seat belt system. The seat belt system may not be able to protect users after damage and may cause serious injury or even death when an accident occurs. After the accident, seat belts should be checked immediately and replaced as necessary.***

Seat belts should not require change after minor collisions, however, some other parts of the seat belt system may

require attention. Please consult an MG Authorised Repairer for advice.



### Airbag Supplementary Restraint System

#### Overview



*The airbag SRS provides ADDITIONAL protection in a severe frontal impact only. It does not replace the need, or requirement to wear a seat belt.*



*The airbags together with the seat belts provide optimum protection for adults, but it is not the case for infants. The seat belt and airbag systems in the vehicle are not designed for protecting infants. The protection required by infants should be provided by child restraints.*

The Airbag Supplementary Restraint System generally consists of:

- Front Airbags (fitted to the centre of the steering wheel and dashboard above the glove compartment)

- Seat Side Airbags (fitted to the outer side of the seat squab)
- Side Head Impact Protection Airbags (fitted behind the headlining)
- Airbag Control Module

Please note that this is model and trim level dependant.

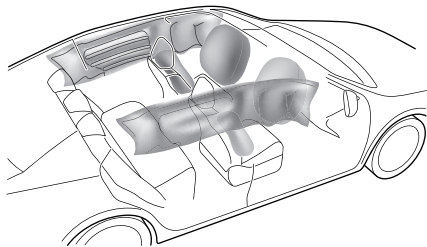

## SEATS & RESTRAINTS

---

In the corresponding position where airbags are fitted, there is a warning sign stating 'AIRBAG'.

### Airbag Warning Light



The airbag warning light is located in the instrument pack. If this lamp does not extinguish or illuminates during driving, it indicates that there is a failure in the SRS or seat belt. Please seek an MG Authorised Repairer at the earliest opportunity. An SRS or seat belt fault may mean the components may not be deployed in the event of an accident.

### Airbag Deployment



*Front seat passengers should not place feet, knees or any other part of the body in contact with, or in close proximity to a front airbag.*



*To minimise the risk of accidental injury from inflating airbags, seat belts should be worn correctly at all times. In addition, both driver and front seat passenger should adjust their seat to provide sufficient distance from the front airbags. If side airbags/side head impact protection airbags are fitted, both driver and front seat passenger should be seated to maintain sufficient distance from the upper part of the body to the sides of the vehicle, this will ensure maximum protection when the side airbags/side head impact protection airbags are deployed.*



**When airbags are deployed, children without proper protection may suffer from serious injury or even death. DO NOT carry children in the arms or on the knees during traveling. Children should wear seat belts suitable to age. DO NOT lean out of windows.**



**An inflating airbag can cause facial abrasions and other injuries if the occupant is too close to the airbag at the time of its deployment.**



**DO NOT affix or place any objects on, or adjacent to the airbags. This may affect the airbag passage or create projectiles that may cause injury or serious harm in the event of airbag deployment.**



**After deployment the airbag components become very hot. DO NOT touch any airbag related components, it may cause burns or serious injury.**



**DO NOT knock or strike the position where airbags or related parts are located, so as to avoid accidental airbag deployment which may cause serious injury or even death.**

In the event of a collision, the airbag control unit monitors the rate of deceleration or acceleration induced by the collision, to determine whether the airbags should be deployed. Airbag deployment is virtually instantaneous and occurs with considerable force, accompanied by a loud noise.

Provided the front seat occupants are correctly seated and with seat belts properly worn, the airbags will provide additional protection to the chest and facial areas in the event of the car receiving a severe frontal impact.

Side airbags and side head impact protection airbags are designed to offer additional protection to the side of the body facing the impact, if a severe side collision occurs.

## SEATS & RESTRAINTS

---

### IMPORTANT

- Airbags can not protect lower body parts of passengers.
- Airbags are not designed for rear collision, minor frontal or side impacts, or if the vehicle overturns; nor will it operate as a result of heavy braking.
- Deployment and retraction of the frontal and side airbags takes place very quickly and will not protect against the effects of secondary impacts that may occur.
- When an airbag inflates, a fine powder is released. This is not an indication of a malfunction, however, the powder may cause irritation to the skin and should be thoroughly flushed from the eyes and any cuts or abrasions of the skin.
- After inflation, front and side airbags deflate immediately. This provides a gradual cushioning effect for the occupant and also ensures that the driver's forward vision is not obscured.

### Front Airbags



***NEVER use a rearward facing child restraint on a seat protected by an ACTIVE AIRBAG in front of it, DEATH or SERIOUS INJURY to the CHILD can occur. Refer to 'Disabling the Passenger Airbag'.***



***Front seat passengers should not place feet, knees or any other part of the body in contact with, or in close proximity to a front airbag.***



***In extreme cases driving on very uneven surfaces may cause airbag deployment. Please take extra care when driving on uneven roads.***

Airbags are designed to deploy during serious impacts, the following conditions may cause airbag deployment.

- A frontal collision with unmovable or non deformable solid objects at a high speed.
- Conditions that can cause serious chassis damage, such as a collision with kerbstones, road edges, deep ravines or holes.

### Seat Side Airbags



*The manufacture and material of the seat is critical to the correct operation of side airbags. Therefore, please DO NOT fit seat covers which may affect side airbag deployment.*

In the event of a serious side impact, the relevant side airbag will deploy (only the affected side).

- The airbag will be deployed in the event that the side of the vehicle is impacted with a solid object or another vehicle.

### Side Head Impact Protection Airbags

In the event of a serious side impact, the relevant side curtain airbag will deploy (only the affected side).

- The side curtain airbag will be deployed in the event that the side of the vehicle is impacted with a solid object or another vehicle.

# SEATS & RESTRAINTS

---

## Conditions in Which Airbags Will Not Deploy

The deployment of airbags does not depend on the vehicle speed, but on the object that the vehicle hits, angle of impact and the rate at which the car changes speed as a result of a collision. When the impact force of collision is absorbed or dispersed to vehicle body, airbags may not deploy; however, airbags may sometimes deploy according to impact condition. Therefore, the deployment of airbags shall not be judged based on the severity of vehicle damage.

### Front Airbags

Under certain conditions the front airbags may not be deployed. Some examples are listed below:

- The impact point is not central to the front of the vehicle.
- The impact is not of sufficient force (the impact is with an object that is not solid, such as a lamp post or central barriers).
- The impact area is high (collision with the tailgate of a truck).
- Impacts to the rear or side of the vehicle.

- The vehicle rolling over.

### Seat Side Airbags and Side Head Impact Protection Airbags

Under certain conditions the seat side and side head airbags may not be deployed. Some examples are listed below:

- Side impacts at certain angles.
- Light side impacts such as a motorcycle.
- Impacts that are not central to the side of the vehicle, either too far toward the engine compartment or the loadspace.
- The vehicle rolling over.
- The angled impact is not of sufficient force (the impact is with an object that is not solid, such as a lamp post or central barriers).
- The impact is not of sufficient force (with another vehicle, stationary or moving).
- The impact is from the rear of the vehicle.

### Disabling the Passenger Airbag



**The Passenger Airbag should only be disabled when a rear facing child seat is fitted to the front passenger seat.**



**When an adult is seated in the front passenger seat, ensure that the airbag is switched on.**

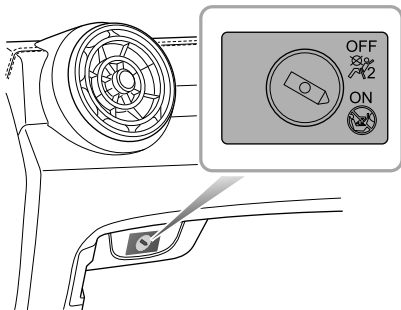

The passenger airbag disable switch is located inside of the glovebox, To disable the passenger airbag, insert the key and turn the switch to OFF position.

**Note:** Please see "Warning Lights and Indicators" in the "Instruments and Controls" section for warning light operation.

**Note:** Please see "Warnings and Instructions on Use of Child Restraint on Front Passenger Seat" in "Seats & Restraints" section.

# SEATS & RESTRAINTS

---

## Service and Replacement of Airbags

### Service Information



***DO NOT install or modify the airbag. Any changes to the vehicle structure or airbag system wiring harness are strictly prohibited.***



***Changes to vehicle structure is prohibited. This may affect the normal operation of the SRS.***



***DO NOT allow these areas to be flooded with liquid and DO NOT use petrol, detergent, furniture cream or polishes.***



***If water contaminates or enters the SRS it may cause damage and affect deployment. In this case contact an MG Authorised Repairer immediately.***

To prevent damage to the airbag SRS, the following areas should be cleaned sparingly with a damp cloth and upholstery cleaner **ONLY**:

- Steering wheel centre pad.
- Area of dashboard containing the passenger airbag.

- Area of roof lining and front pillar finishers which enclose the side head impact protection modules.

If the airbag warning lamp fails to illuminate, stays on, or if there is damage to the front or side of the vehicle, or the airbag covers show signs of damage, contact an MG Authorised Repairer immediately.

### IMPORTANT

- The removal or replacement of an airbag module should be carried out by an MG Authorised Repairer.
- After 10 years from the initial date of registration (or installation date of a replacement airbag), some components will need to be replaced by an MG Authorised Repairer. The appropriate page of the Warranty and Maintenance Manual must be signed and stamped once the work has been completed.



### Replacing Airbag System Parts



***Even if the airbag does not deploy, collisions may cause damage to SRS in the vehicle. Airbags may not function properly after damage, and can not protect you and other passengers when a second collision occurs, which may cause serious injury or even death. To ensure that SRS can function properly after collision, please go to an MG Authorised Repairer to check airbags and repair as necessary.***

Airbags are designed for using once only. Once the airbag is deployed, you must replace SRS parts.

Please go to an MG Authorised Repairer for replacement.

### Disposal of Airbags

When your vehicle is sold, ensure that the new owner knows the vehicle is equipped with airbags, and is aware of the replacement date of SRS.

If the vehicle is scrapped, the undeployed airbags may have potential risks, therefore, before the disposal, they must be deployed safely in a certain environment by a professional from an MG Authorised Repairer.

# SEATS & RESTRAINTS

---

## Child Restraints

### Important Safety Instructions about Using Child Restraints

It is recommended that children below the age of 12 years old should be seated on the rear seat of the vehicle, in a child restraint system appropriate to the children's weight and size. Infants less than 2 years old should be restrained in an infant child restraint system.

It is recommended that a child restraint system that complies with UN ECE-R44 or ECE-R129 standard are fitted in this vehicle. Check markings on the child restraint system.

There are a number of child restraint systems available of different type and specification. For optimum protection, it is recommended that you choose restraint systems appropriate to the child's age and weight.

It is important to comply with installation instructions supplied by the child restraint manufacturer and that child restraint system is properly secured to the vehicle. Failure to follow these instructions may cause death or serious injury to the child in an event of a sudden stop or accident.

- All occupants, including children must wear seat belts or use an appropriate child restraint.
- It is recommended that children under 12 years of age or less than 1.5 metres tall should use the appropriate child restraint fitted to the rear seat.
- Only one child can be carried in any one restraint.
- Do not put the child on the lap or in arms when sitting in any seat.
- Always adjust the seat back rest to a central position and ensure it is locked in position when installing a child seat or restraint.
- If installing a rear facing child restraint to the rear seat, the corresponding front seat should be adjusted forward; if installing a forward facing child restraint to the rear seat, you may need to adjust the height of the headrest to the lowest; if installing a forward facing child restraint to the front seat, you may need to remove its headrest.
- Never let your child stand or kneel on the seat during driving.
- Always ensure the child is seated correctly in the child restraint.

- The ways of using seat belts have a great influence on the maximum protection offered by the seat belt, you must comply with the child restraint manufacturer's instructions on proper use of seat belts. If seat belts are not properly fastened, a minor traffic accident may also lead to injury.
- Child restraints that are not fitted correctly may move and injure other occupants in the event of an accident or emergency braking. Therefore, even if there is no infant or child in the child restraint, it also should be fitted properly and securely in the vehicle.

### Warnings and Instructions on Use of Child Restraint on Front Passenger Seat



*When the front passenger airbag is active, never install a rear facing child restraint on the front passenger seat, severe injury or even death can occur.*



*In cases where there is a need to install a rear facing child restraint on the front passenger seat, use the key to deactivate the front passenger airbag function, or severe injury or even death can occur.*



*Once the child restraint is removed from the front passenger seat, use the key to reactivate the front passenger airbag.*



*When installing a child restraint on the front passenger seat, move the front passenger seat as far rearward as possible.*



*Use one child restraint per child.*

## SEATS & RESTRAINTS

---

Please study the safety warning label on the sun visor. Where possible always install child restraints on the rear seat. If it is necessary to install a child restraint on the front seat please observe the warnings above.

### Children's Safety and Side Airbags



***Children should not be allowed in areas where airbags may be deployed, there is a risk of serious injury.***



***Only recommended child restraints suitable for the age, height and weight of the child should be used.***



***DO NOT place any items in areas where airbags may be deployed, there is a risk of serious injury.***

In the event of a side collision, the side airbags can provide better protection for the passenger. However, when the airbag is triggered a very strong expansion force is generated, if the passenger's seating position is not correct,

the airbags or items in the side airbag deployment area may cause injury.

When the correct child restraint is used to secure the child properly in the rear seat and the child's seating position is correct, there is enough space between the child and the side airbag deployment region for the airbag to deploy without any hindrance, and thus provide the best protection.

### Child Restraints Groups

#### Secured Using 3 Point lap Diagonal Belts



**Please DO NOT put the rear facing child restraint in the front passenger seat, this may cause serious injury or even death.**

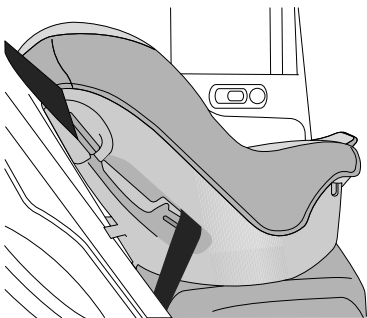

It is recommended that children should always be seated in the rear of the vehicle in a child restraint or restraint system, and fixed with 3 point, lap diagonal seat belts.

### ISOFIX Child Restraint Systems



**The ISOFIX anchorages in the rear seat are designed for use with ISOFIX systems only.**



**Child restraint anchorages are designed to withstand only those loads imposed by correctly fitted child restraints. Under no circumstances are they to be used for adult seat belts, harnesses, or for attaching other items or equipment to the vehicle.**

**Note:** When installing and using any child restraint system, always follow the manufacturer's instructions.

**Note:** The rear seats fitted to this vehicle are provided with the ISOFIX interface (as indicated by the arrow in the following image), these are designed to connect to an ISOFIX child seat.

## SEATS & RESTRAINTS

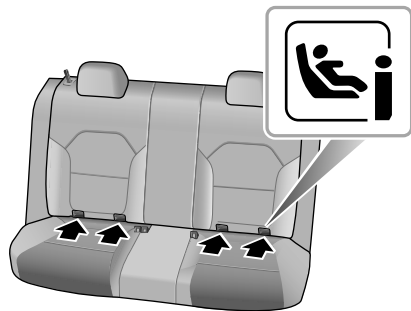

- Fasten vehicle-approved ISOFIX child restraint systems to the mounting brackets.
- When using ISOFIX mounting brackets for seat mounting, universally approved child restraint systems for ISOFIX may be used.

**Note: When using seat mounting, universally approved child restraint systems, Top-tether must be used.**

**Note: Please refer to the child restraint system manufacturer's instructions for details.**

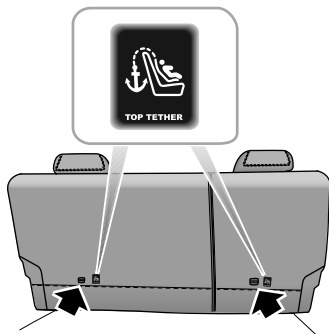

- To fasten the Top tether strap of the child restraint system, route the tether strap under the head restraint and attach to the anchorage hook being careful not to twist the strap. If not using ISOFIX lower anchorages, using the seatbelt, complete the installation in line with the child restraint manufactures instructions.

- After installation apply suitable force to ensure the restraint is securely fastened.

## SEATS & RESTRAINTS

### Approved Child Restraint Positions

It is recommended that a child restraint system that complies with UN ECE-R44 or ECE-R129 standard are fitted in this vehicle. Check markings on the child restraint system.

### Approved Child Restraint Positions (for non ISOFIX Child Restraints)

Mass Group	Seating Positions				
	Front Passenger			Rear Outboard	Rear Middle
	Without Front Passenger Airbag OFF Switch	With Front Passenger Airbag OFF Switch			
		Airbag ON	Airbag OFF		
0 group (less than 10 kg)	X	X	X	U	X
0+ group (less than 13 kg)	X	X	X	U	X
I group (9 ~ 18 kg)	X	X	U	U	X
II group (15 ~ 25 kg)	U	U	U	U	X
III group (22 ~ 36 kg)	U	U	U	U	X
Note: Description of letters in the table: U = Suitable for universal child restraint systems approved for this mass group; X = Seat position not suitable for child restraint systems in this mass group.					



## Approved Child Restraint Positions (for ISOFIX Child Restraints)

Seating Position		Mass group categories			
		0 group	0+ group	I group	
		Rear facing		Forward facing	Rear facing
		Up to 29 lbs(13 kg)		20–40 lbs(9 ~ 18 kg)	
Front Passenger Seat	Size Class	Not ISOFIX equipped			
	Seat Type				
Rear Outboard Seat ISOFIX	Size Class	C,D,E <sup>1</sup>	A,B, BI <sup>1</sup>	C,D <sup>1</sup>	
	Seat Type	IL <sup>2</sup>	IL <sup>2</sup> ,IUF <sup>3</sup>	IL <sup>2</sup>	
Rear Centre Seat	Size Class	Not ISOFIX equipped			
	Seat Type				

Note: IL Suitable for particular ISOFIX child restraints systems of the semi-universal category. Please consult child restraints systems suppliers' vehicle recommendation lists;

IUF Suitable for ISOFIX forward facing child restraints systems of universal category approved for use in this mass group and ISOFIX size class;

<sup>1</sup>. The ISOFIX size class for both universal and semi-universal child seat systems is defined by the capital letters grade A ~ G. These identification letters are displayed on the ISOFIX child seat;

## SEATS & RESTRAINTS

---

2. At time of publishing the recommended Group 0+ ISOFIX baby safety seat is the Britax Romer Baby Safe. Consult an MG Authorised Repairer for the latest details relating to our recommended child seats;
3. At time of publishing the recommended Group I ISOFIX child seat is the Britax Romer Duo. Consult an MG Authorised Repairer for the latest details relating to our recommended child seats.

Note: At time of publishing the recommended Group II-III ISOFIX child seat is the KidFix XP. Consult an MG Authorised Repairer for the latest details relating to our recommended child seats.

### Table of I- Size child seats

The table gives a recommendation for which I- Size child seats suit which locations, and for what size of child.

The child seat must be approved in accordance with UN Reg R129.

Type of child seat	Front passenger seat	Rear outboard seats	Rear centre seat
I- Size child restraint systems	X	I-U	X

Note: I-U Suitable for use with forward and rear facing I- Size child restraint systems.

X Not suitable for use with I- Size restraint systems.

### Group 0/0+ Child Restraint



*When the front passenger airbag is active, never place a rear facing child restraint on the front passenger seat, severe injury or even death can occur.*

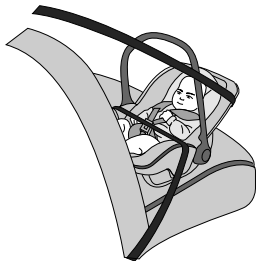

Child restraints that can be adjusted to lying position are most suitable for infants who are lighter than 10 kg (normally for those younger than 9 months) or those who are lighter than 13 kg (normally for those younger than 24 months).

### Group I Child Restraint



*When the front passenger airbag is active, never place a rear facing child restraint on the front passenger seat, severe injury or even death can occur.*



Backward/forward child restraints are most suitable for infants whose weight is 9 ~ 18 kg (normally for those older than 9 months and younger than 4 years old).

## SEATS & RESTRAINTS

---

### Group II Child Restraint



*The diagonal section of the seat belt should pass across the shoulder and upper body, away from the neck. The lap section of the belt should pass across the hips, away from the abdomen.*



The combination of child restraint and 3 point lap diagonal seat belt is most suitable for children whose weight is 15 ~ 25 kg (normally for those older than 3 years old and younger than 7 years old).

### Group III Child Restraint



*The diagonal section of the seat belt should pass across the shoulder and upper body, away from the neck. The lap section of the belt should pass across the hips, away from the abdomen.*



The combination of child booster seat and vehicle 3 point lap diagonal seat belt is most suitable for children whose weight is 22 ~ 36 kg and whose height is below 1.5 m (normally for those about 7 years old or those older than 7 years old).

## Starting & Driving

---

- 158 Keys
- 162 Child Proof Locks
- 163 Alarm System
- 169 Starting and Stopping Engine
- 174 Economical and Environmental Driving
- 178 Catalytic Converter and Particulate Filter
- 180 Fuel System
- 182 Automatic Transmission \*
- 189 Manual Transmission \*
- 191 Brake System
- 197 Automated Stop/Start —Intelligent Fuel Saving System \*
- 202 Stability Control System (SCS) and Traction Control System (TCS)
- 203 Cruise Control System
- 206 Active Speed Limit (ASL) System
- 209 Parking Aid \*
- 213 Tyre Pressure Monitoring System (TPMS)
- 215 Load Carrying

# STARTING & DRIVING

## Keys

### Overview



**Keep the spare key in a safe place - not in the vehicle!**



**It is recommended that spare keys are not kept on the same key ring, since this may cause interference and prevent correct key recognition and therefore prevent the engine from starting.**



**The remote key contains delicate electronic components and must be protected from impact and water damage, high temperature and humidity, direct sunlight and the effects of solvents, waxes and abrasive cleaners.**

Two remote keys are provided. They can open all locks.

The keys supplied to you have been programmed for the security system on your vehicle. Any key that is not programmed to your vehicle can not start the engine.

The remote key only works within a certain range. Its operating range is sometimes influenced by the key battery condition, physical and geographical factors. For safety consideration, after you lock your vehicle by the remote key, please recheck if the vehicle is locked.

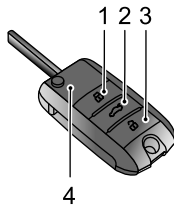

- 1 Lock button
- 2 Tailgate release button
- 3 Unlock button

### 4 Remote key

If your key is lost/stolen or broken, a replacement can be obtained from an MG Authorised Repairer. The lost/stolen key can be deactivated. If the lost key is found, an MG Authorised Repairer can reactivate it.

**Note:** Any key made independently outside of MG Authorised Repairer Network may not start the engine, and may affect the safety of your car. To obtain a suitable key replacement, it is recommended that you can consult MG Authorised Repairer.

**Note:** The new key cannot be offered to you immediately because it requires programming to the vehicle by the MG Authorised Repairer.

**Note:** Avoid operating the remote key close to strong radio interference devices (such as computer and other electronic products), or the normal function of the key may be affected.

### Replacing Battery in Remote Key

Please use the picture guide to replace remote key battery if any of the following conditions occur:

- The keys locking/unlocking function range is reduced.
- The engine immobilisation warning lamp on the instrument pack flashes (Refer to "Warning Lamps and Indicators" in "Instruments and Controls" section).

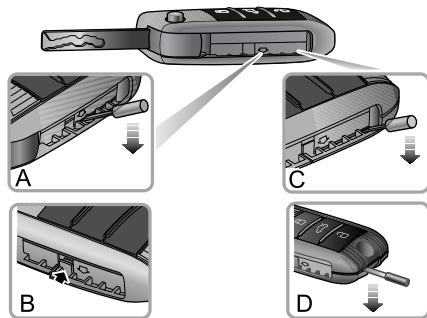

## STARTING & DRIVING

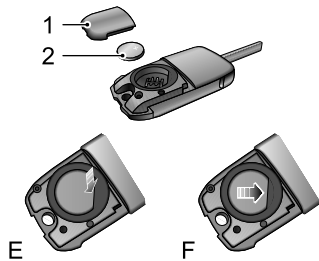

- 1 Unfold the remote key.
- 2 With a flat-bladed tool, insert it below the arrow mark at the side of the key (A), and pry up the battery cover carefully until the lock pins are separated (B).
- 3 Then insert the flat-bladed tool into the illustrated position (C), and apply pressure in the direction indicated by the arrow until the tail of the key makes a gap.

- 4 Continue to use the flat-bladed tool inserting it into the end of the key/battery cover (D), slightly pry the battery cover until the two bayonets at the end of battery cover are released.
- 5 Carefully prise off the battery cover (1).
- 6 Press the front part of button battery using slight force (E) to remove the battery (2).
- 7 Position the new battery, ensuring that correct polarity is maintained ("+" side facing up), slide it forward (F) ensuring it is fully inserted into the slot.

**Note:** Make sure the polarity is correct (positive side upward).

**Note:** It is recommended to use the CR2032 replacement battery.

- 8 Refit the cover and press tightly, check the gap around the cover is even.
- 9 Insert the remote key into ignition switch to resynchronise it.



### IMPORTANT

- Use of an incorrect or inappropriate battery may damage the remote key. The new replacement's rated voltage, sizes and specifications must be the same as the old one.
- Incorrect fitting of the battery may damage the key.
- Disposal of the used battery must be strictly in accordance with relevant environmental protection acts.

## STARTING & DRIVING

---

### Child Proof Locks



**NEVER** leave children unsupervised in the vehicle.

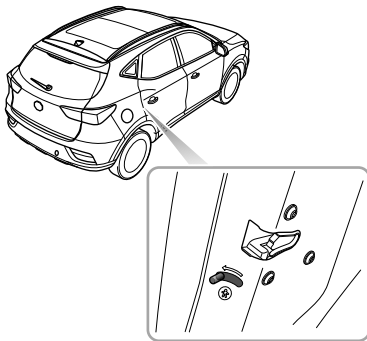

- Open the rear door at corresponding side, move the child proof lock lever to the lock position in the direction of the arrow to engage the child proof lock;
- Move the lever to the unlock position in the reverse direction of the arrow to disable the child proof lock.

With the child proof lock locked, the rear door at the corresponding side cannot be opened from inside the car, but can be opened from outside the car.

Steps for enabling or disabling the child proof locks are as follows:

### Alarm System

Your car is fitted with an electronic anti-theft alarm and engine immobilisation system. To ensure maximum safety and operation convenience, we strongly recommend you to carefully read this chapter to fully understand the activation and deactivation of anti-theft systems.

### Engine Immobilisation

Engine Immobilisation is designed to safeguard the vehicle from theft. Engine Immobilisation can only be deactivated to start the engine by using the matched key.

### Engine Immobilisation

When the matched key is inserted into the ignition switch and the car is started, engine immobilisation is deactivated automatically. When the key is removed from the ignition switch, the vehicle will automatically enable engine immobilisation. When the ignition switch is in the ON position, if the engine immobiliser cannot identify the key inserted into the ignition switch, the engine immobilisation warning lamp in the instrument pack illuminates. If the

engine still can not be started by using the spare key, please contact a local MG Authorised Repairer.

# STARTING & DRIVING

---

## Electronic Anti-theft Alarm System

### Locking and Unlocking

#### Key Locking

- Using the remote key to lock: press the lock button on the remote key to lock the car after closing the doors, bonnet and tailgate.
- Using the mechanical key to lock: open the door lock trim cover, insert the key into the driver door lock and turn counterclockwise to lock all doors.

#### Key Unlocking

- Using the remote key to unlock: press the unlock button on the remote key once to unlock all doors.
- Using the mechanical key to unlock: open the door lock trim cover, insert the key into the driver door lock and turn clockwise to unlock all doors.

**Note: If the ignition switch is not placed in ACC or ON/RUN/START position within 15 seconds after the vehicle is unlocked with the mechanical key, the engine immobilisation alarm will be triggered.**

**Note: If no panels are opened within 30 seconds after the vehicle is unlocked by using the remote key, all doors will automatically re-lock.**

#### Mislock

If the driver's door is not fully closed when the handset lock button is pressed, the vehicle horn will sound once, indicating a mislock. In this case, none of the doors will lock, the alarm system will not be armed and the direction indicator lights will not flash.

If the driver's door is closed, the passenger door, bonnet and tailgate are not fully closed, the horn sounds once to indicate mislock when the car undergoes locking operation. However, the 'partial arming' attributes of the security system will enable as much of the system to be armed as possible (all fully closed doors, bonnet or tailgate apertures will be protected, but an open door will not!). The alarm indicator will flash. As soon as the open aperture is closed, the system will automatically revert to an armed state.

### Anti-theft Alarm Sounder

If the anti-theft alarm has been activated the sounder will operate 10 times, each for 30 seconds. Pressing the lock or unlock button on the remote key will stop the horn sounding.

### Interior Lock Switch

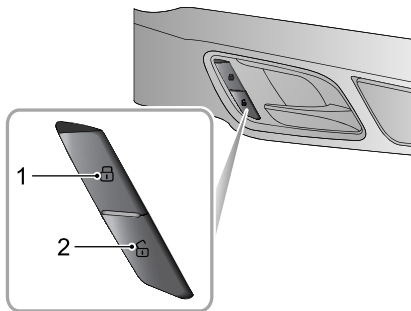

- 1 Lock Switch
- 2 Unlock Switch

When the anti-theft alarm system is not in operation, press the lock switch (1) to lock all doors; press the unlock switch (2) to unlock all doors.

## STARTING & DRIVING

---

**Note:** *If the anti-theft alarm system is switched on, pressing the lock/unlock button will not lock/unlock the doors but will trigger the alarm system.*

If the doors, bonnet and tailgate are closed, press the interior lock switch. The yellow indicator on the interior lock switch illuminates.

If a mislock is caused by non-driver door, tailgate or bonnet, press the interior lock switch. The yellow indicator on the interior lock switch illuminates.

### Interior Door Handles

When the anti-theft alarm system is not in operation, use the interior door handle to open the door:

- 1 Pull the interior door handle once to unlock the door.
- 2 Pull the interior door handle again to open the door.

### Speed Lock \*

All the doors will be locked automatically when the road speed exceeds 10 mph (15 km/h).

### Automatic Unlock

When the ignition switch is switched to the OFF position, all the doors will be unlocked automatically.

### Tailgate



*If the tailgate can not be closed due to the type of cargo loaded, be sure to close all windows during driving, select the face distribution mode of the air condition, and set the blower to maximum speed, so as to decrease exhaust fumes entering the vehicle.*

### Tailgate Open Mode

The tailgate can be opened by using the following 2 methods:

- 1 When the vehicle is unlocked, open the tailgate by turning over the emblem on the tailgate (Figure A).
- 2 With the ignition switch in the OFF position, press the release button on the remote key (Figure B) for more than 2 seconds to open the tailgate.

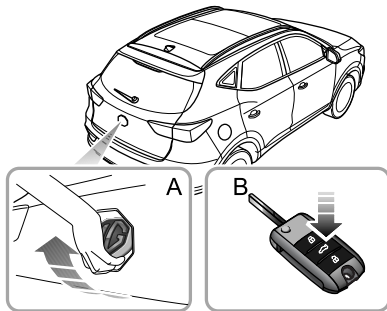

## STARTING & DRIVING

---

### Emergency Tailgate Opening

The emergency tailgate release access is located in the centre of the tailgate trim.

Fold down the rear seat to gain access, remove the blanking plug, insert a suitable flat bladed tool into the opening slot and release the tailgate lock.

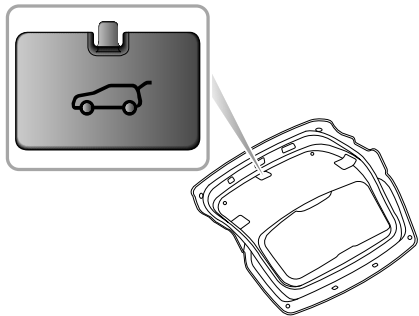



## Starting and Stopping Engine

### Ignition Switch



*When the vehicle is in motion, DO NOT switch off the ignition or remove the key, otherwise the steering wheel may be locked, making it impossible to turn the vehicle.*



*When the vehicle is in motion, DO NOT touch the key to avoid engine flameout!*

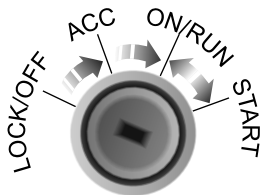

The ignition switch is located on the right side of the steering column. Function of each position is as follows:

#### **Position LOCK/OFF**

- The key can be inserted or removed.
- After the engine is stopped and the key is removed, turn the steering wheel to one side to lock the steering wheel.

#### **Position ACC**

- The engine is not started and the key cannot be removed.
- Some individual electrical equipment and accessories can be operated, such as power windows, electric rearview mirrors.

#### **Position ON/RUN**

- All electrical equipment is operational.
- After the vehicle is started, the engine runs.

#### **Position START**

- Start engine. When the engine is starting, some electrical equipment will be isolated during cranking.

## STARTING & DRIVING

---

- Release the key immediately after the engine is started, the ignition switch will return to position ON/RUN automatically.

**Note:** *When the ignition switch is in position OFF, if the driver side door is opened, an audible warning sounds to indicate that the key is not removed.*

**Note:** *When the steering wheel is locked and the key cannot be turned from position OFF to position ACC, please turn the steering wheel slightly whilst turning the key to unlock the steering wheel.*

### Starting the Engine



**Never start or leave the engine running in an unventilated building. Exhaust gases are poisonous and contain carbon monoxide, which can cause unconsciousness and may even be fatal.**



**Catalytic converters and particulate filters can be damaged if the wrong fuel is used, or if an engine misfire occurs. Before starting the engine, please read carefully the contents in the "Catalytic converter and Particulate Filter" section.**

### Operation of Starting the Engine

- 1 Switch off all unnecessary electrical equipment (including the air conditioning);
- 2 Apply the parking brake (refer to "Brake System" of this section);
- 3 For auto transmission vehicles, ensure the shift lever is in P or N position;

**Note:** When the shift lever is in any other position, the engine cannot be started.

- 4 For manual transmission vehicle, ensure neutral is selected and the clutch pedal is fully pressed;
- 5 Insert the key, rotate it to position START and release the key immediately after the engine is started.

**Note:** After the engine starts, if the key is not released immediately, the starter will continue to work, which will not only discharge the battery, but also damage the starter and starter motor, catalytic converter and particulate filter.

### Precautions for Starting the Engine

DO NOT press the accelerator pedal while starting and DO NOT operate the starter for more than 15 seconds at a time. If the engine fails to start, turn off the ignition switch and wait at least 10 seconds before trying again.

If the key inside the vehicle can not be recognised by the engine immobiliser, the engine will not start. The relevant alarm icon will appear on the instrument pack (refer to "Warning Lamps and Indicators" in "Instruments and Controls" section).

Idle speed will decrease after engine warm-up. Do not increase engine speed immediately after engine starts. Progressively operate the engine and transmission so that oil can preheat and lubricate all operating components.

If the remote key is not in the vehicle or subject to some interference, the corresponding alarm icon will appear on the information centre display; if the battery inside the remote key needs to be replaced, the corresponding alarm icon will appear on the instrument pack (refer to "Warning Lamps and Indicators" in "Instruments and Controls" section), and you can still drive the vehicle.

## STARTING & DRIVING

---

In temperatures of  $-10^{\circ}\text{C}$  and below, engine cranking times will increase. It is essential that all unnecessary electrical equipment is switched off while cranking.

### IMPORTANT

- If you try to start consecutively for 3 times and it fails, please seek assistance. When attempting to start the car consecutively please allow 10 minutes between attempts to allow battery restoration and engine cooling, failure to do this may result in battery or engine damage.
- DO NOT leave the ignition switch in the ACC, ON/RUN or START positions for any length of time when the engine is not running, otherwise it may lead to battery discharge due to the use of electrical equipments.
- The vehicle is fitted with engine immobilisation system. Any independently made key cannot start the engine.
- Your car is controlled by electronic control systems. When starting the engine, please make sure there are no electronic devices that can create electromagnetic interference near the vehicle. This may cause issues with the electronic control systems on the vehicle.

### Stopping the Engine

Stop the engine as follows:

- 1 After bringing the car to a stop, continue to apply the footbrake until the parking brake is applied;
- 2 Apply parking brake;
- 3 For vehicles with automatic transmission, ensure that the shift lever is in P position.

**Note:** *If the parking brake is applied but the shift lever is not fully in the parking (P) position, then there may be a risk of the vehicle suddenly moving and causing injury to yourself or others when starting the engine.*

- 4 For vehicles with manual transmission, ensure that the shift lever is in neutral position.
- 5 Turn the key from ON/RUN position to LOCK/OFF position, the engine will be shut down and the key can be removed.

**Note:** *After strenuous towing or driving at high speed (particularly in hot weather), it is suggested*

*to allow the engine to idle for a few minutes before switching off, which enables the cooling system to work continuously to lower the engine temperature.*

# STARTING & DRIVING

---

## Economical and Environmental Driving

### Running-in

The engine, transmission, brakes and tyres need time to 'bed-in' and adjust to the demands of everyday motoring. During the first 900 miles, it is essential that you drive with consideration for the running-in process and heed the following advice:

- Do not allow the engine to exceed 3000 rpm in any gear or the vehicle speed to exceed 72 MPH.
- Do not operate at full throttle or allow the engine to labour in any gear.
- Do not drive at a constant speed (either high speed or low speed).
- Avoid heavy braking where possible.

After 900 miles, engine speeds can be gradually increased.

### Environment Protection

Your vehicle has been designed with the latest technology in order to minimize the environmental impact of exhaust emissions.

## Driving Style

The way in which you drive your car has a significant bearing on environmental pollution, as well as affecting the amount of fuel you use.

### Avoid full throttle acceleration

Steady, rather than rapid, acceleration uses considerably less fuel, reduces exhaust pollutants and also minimizes the wear to mechanical components.

### Avoid driving at maximum speed

Fuel consumption, exhaust emissions and noise levels all increase significantly at high speeds.

### Do not drive in a low gear for longer than necessary

Driving in lower gears uses more fuel and creates more noise. Change up to a higher gear as soon as possible, provided it does NOT cause the engine to labour.

### Drive smoothly

Anticipating obstructions and slowing down well in advance, avoids the need for unnecessary acceleration and harsh braking. A smooth driving style not only reduces fuel consumption, but can reduce the emission of noxious gases.

### Driving in rain



***Emergency braking, accelerating and steering on slippery roads will reduce the vehicle's handling performance and grip.***

When raining the windows may fog, reducing visibility (Use the Air-conditioning demist function).

Grip will be reduced, so please drive carefully.

Reduce speed when it rains.

Avoid aquaplaning (the effect of a film of water between the tyres and the road) affecting steering and braking performance.

Your MG is equipped with Brake Disc Wiping, activated by the wipers or rain sensor (where fitted). This will help

to keep the brake pads and discs clear of water and help restore brake performance.

Avoid driving through floods after heavy rain, which may lead to serious damage to the vehicle.

### Fuel Saving and Extending Vehicle Life

The following are some suggestions on saving fuel and extending the life of the vehicles.

- Maintain the correct tyre pressure; insufficient air pressure will accelerate tyre wear and waste fuel.
- Do not carry unnecessary weight. Heavy loads will increase the engine load resulting in higher fuel consumption.
- Avoid engine idling for extended periods.
- Maintain slow and smooth acceleration and avoid harsh acceleration; change to a higher gear as soon as possible.
- Avoid labouring the engine or over running. Choose appropriate gears according to the road conditions.
- Avoid continuous acceleration or deceleration. A stop-go driving style will consume more fuel.

## STARTING & DRIVING

---

- Avoid unnecessary stopping and braking, maintain steady speed and attempt to anticipate traffic lights. Keep an appropriate distance from other vehicles to avoid emergency braking and reduce brake pad wear.
- Avoid traffic congestion and jam areas as much as possible.
- Do not ride the brake pedal, this can cause premature wear, overheating and increased fuel consumption.
- Maintain an appropriate speed on the highway. Higher speeds use more fuel. Appropriate speed can save fuel.
- Maintain the correct wheel alignment. Avoid collision with the kerb and reduce speed on uneven road surfaces. Out of specification wheel alignment will not only lead to excessive tyre wear, but also increases the engine load and fuel consumption.
- Avoid driving on mud or beaches. This will prevent corrosion of the vehicle underside.
- Maintain the vehicle in accordance with MG recommendations. Dirty air filters, oil etc., will reduce the engine's performance and raise fuel consumption. To extend the life of all components and reduce operating costs, regular MG Approved maintenance is needed.
- Do not stop the engine straight after high speed or long ascents or towing a trailer. Allow the engine to idle for 20 to 100 seconds depending upon driving loads and conditions. Avoid hard acceleration on a cold engine.



### **Maintenance**

#### **Have the vehicle regularly serviced**

Regular servicing will ensure optimum fuel consumption and minimize exhaust pollutants, as well as effectively extending the service life of the car.

#### **Check tyre pressures regularly**

Under-inflated tyres increase the rolling resistance of the car which, in turn, increases fuel consumption. Over or under-inflated tyres wear out more rapidly and also have a detrimental effect on the car's handling characteristics.

#### **Do not carry unnecessary loads**

The additional weight of unnecessary loads wastes fuel, especially in stop/start conditions where the car is frequently required to set off from stationary.

## STARTING & DRIVING

### Catalytic Converter and Particulate Filter



The temperatures of exhaust systems that contain particulate filters and catalytic converters can be extremely high, **DO NOT** park on ground where combustible materials such as dry grass or leaves could come into contact with the exhaust system - in dry weather a fire could result.

**Note:** Only 1.0T EU6D models feature a particulate filter.

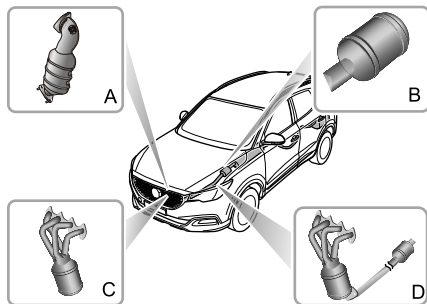

The exhaust system incorporates a catalytic converter and particulate filter (model dependant), these process possible harmful exhaust emissions from the engine into more environmentally friendly gases. Exhaust system layouts differ between engine derivatives and EU6B/EU6D compliance. The 1.0T EU6B exhaust features (A) and EU6D features (A & B). The 1.5L EU6B exhaust features (C) and EU6D features (D).

Catalytic converters and particulate filters are easily damaged through improper use, especially if the wrong fuel or oil to the incorrect specification is used.

### **Fuel**

- Use only fuel recommended for your car.
- Never allow the car to run out of fuel – this could cause serious damage to the catalyst system.

### **Engine Oils**

- It is recommended that only oils that meet the manufacturers specification are used. Use of oils that do not meet the manufacturers specifications can damage the particulate filter, for example low SAPS oils can affect particulate filter ash capacity.

### **Starting**

- Do not continue to operate the starter after a few failed attempts; seek an MG Authorised Repairer.
- Do not operate the starter if an engine misfire is suspected and do not attempt to clear a misfire by pressing the accelerator pedal.
- Do not attempt to push or tow start the car.

### **Driving**

Please pay attention to the following conditions:

- Do not overload or excessively 'rev' of engine.
- Do not stop the engine when the car is in motion with a gear selected.
- Seek an MG Authorised Repairer if you think your car's oil consumption is abnormal.
- If a misfire is suspected, or the car lacks power while driving, provided the engine has reached its normal operating temperature, it may be driven SLOWLY (at risk of catalyst and particulate filter damage) to an MG Authorised Repairer.
- Do not drive on terrain likely to subject the underside of the car to heavy impacts.

**Note: Any engine misfire, loss of engine performance or engine run-on, could seriously damage the catalytic converter and particulate filter. Regular maintenance must be carried out in accordance with the schedule specified in the 'Warranty and Maintenance Manual'. Any modifications to engine without being authorised is prohibited.**

# STARTING & DRIVING

---

## Fuel System

### Fuel Requirements



***Use only the recommended fuel which meets national standard! Serious damage to the catalytic converter and GPF, a reduction in engine power/torque and increase in fuel consumption will occur if the wrong fuel is used.***

Please use the fuel which is recommended and certified by the manufacturer. See 'Major Parameters of Engine' in 'Technical Data'.

If a lower grade of fuel is used, an engine knocking noise may occur, please use the recommended or above grade fuel as soon as possible. If the engine knocking noise is still noticeable after using the recommended or above grade fuel, please contact MG Authorised Repairer immediately.

### Safety Precautions in a Fuel Filling Station



***Vehicle fuel gases are highly flammable and, in confined spaces, are also extremely explosive.***

Always take care when refueling:

- Switch off the engine.
- Do not smoke or use a naked flame.
- Do not use a mobile phone.
- Avoid spilling fuel.
- Do not overfill the tank.

### Fuel Filler

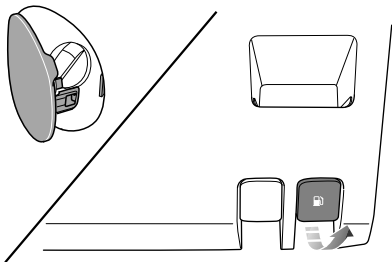

### Fuel Filler Flap

The fuel filler flap is located on the rear right-hand wing. Pull the fuel filler flap release handle under the driver side instrument pack to open the flap.

### Fuel Filler Cap

Unscrew the filler cap anti-clockwise and allow any pressure inside the tank to escape, before removing the cap.

After refueling, tighten the filler cap clockwise until you hear 3 "click" sounds.

### Refueling

Do not fully fill the tank if the vehicle is to be parked in direct sunlight, or high ambient temperature - expansion of the fuel could cause spillage. The fuel filler tube is designed to accept a narrow, long filler nozzle. There is a cover at the filler neck, by inserting the filler nozzle thoroughly before fuel filling, the cover can be fully opened.

Start the engine after fuel filling. After refueling, if the engine runs unevenly, switch off and seek an MG Authorised Repairer before attempting to restart the engine.

# STARTING & DRIVING

---

## Automatic Transmission \*

### Instructions

The following information is very important, please read carefully before use.

- Before starting the engine, place the gear lever in P or N position, ensure the foot brake is pressed and the parking brake is applied.
- After the engine has started, ensure the foot brake and parking brake are applied, shift the lever to the required gear.
- Release the parking brake and hold the foot brake until you are ready to manoeuvre the vehicle. Once the foot brake is released, on flat road, the vehicle will automatically start off at a slow speed without application of the accelerator.
- Do not move the gear shift lever into P or R from D whilst driving, this will cause severe transmission damage or cause an accident.

**Note:** *The gear shift lever cannot be moved from the P position if the battery is disconnected, car has no*

*power, key is not inserted into the ignition switch or foot brake is not applied.*

***In an emergency if the gear shift lever will not move from the P position, please contact an MG Authorised Repairer.***

## Gear Shift

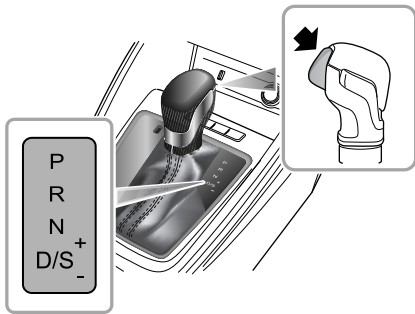

The automatic transmission is a 6 speed transmission.

**Note:** The highlighted letters or numbers in the information centre indicate the selected gear or mode.

A sprung loaded lock button, located in the gear lever, is used to prevent mistakingly selecting P (Park) or R (Reverse) whilst the gear selector is in other positions.

## Shift Lever Operation



Unless necessary, it is not recommended to press lock button during gear shifting.

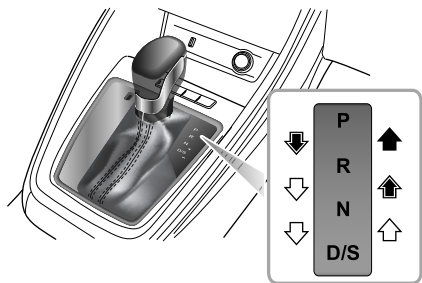

During the gear shift, operate the shift lever according to the instructions indicated by the following arrows:

# STARTING & DRIVING

---



Free gear shift.



Press and hold the lock button to shift the gear.



Press and hold the lock button and step on the brake pedal to shift gear.

## Shift Lever Position



**The shift lever must be placed in P position when parked.**



**DO NOT move the gear shift lever into P or R from D whilst driving, this will cause severe transmission damage or cause an accident.**

- P Park

When the shift lever is in this position, the transmission will be mechanically locked. Use this gear only when the vehicle is stationary and the parking brake is applied.

**Note: When the vehicle is parking on a hill, press the brake pedal and apply the parking brake first and then select P gear.**

- R Reverse

Select this gear only when the vehicle is stationary and the engine is running at idle speed.

- N Neutral

Select this gear when the vehicle is stationary and the engine is running at idle speed for a short time (for example, waiting for traffic lights).

- D Drive

This is used for normal driving and will allow automatic selection of 6 gears depending on vehicle speed and accelerator position.

- S Sport Mode

Select this mode when a more sporty acceleration performance is required.

- + Upshift

Whilst in Manual mode, upshift the transmission to the next available high gear.

- - Downshift

Whilst in Manual mode, downshift the transmission to the next available low gear.



### Gearshift Speed

Selecting D will allow the transmission controller to carry out gearshifts taking in consideration of a number of factors including engine speed, vehicle speed and accelerator position. Light accelerator pedal application will result in a gear-change at low speeds, larger pedal applications will result in gear-changes at higher speeds.

### Kick-down



***The drive wheels may skid when kick-down is activated on road surfaces with low adhesion, this may lead to the vehicle sliding out of control.***

With D gear selected, pressing the accelerator pedal all the way down in one motion (also known as Kick-down) will provide better acceleration performance during overtaking. Under certain conditions, it will allow the transmission to shift to a lower gear immediately, and provide fast acceleration. Once the accelerator pedal is released, it will resume to a suitable normal high gear

(based on the vehicle speed and the position of the accelerator pedal).

### Vehicle Start-off

The vehicle can only be started with the brake pedal pressed and P or N selected; after selecting the desired gear, and waiting for the full engagement of the transmission, release the brake pedal, the vehicle will automatically start off at a slow speed.

# STARTING & DRIVING

---

## Control Mode

### Economy Mode

Selecting D automatically places the vehicle in the Economy Mode. The information centre display will show "D". Economy Mode provides optimum fuel consumption and emissions.

### Sport Mode

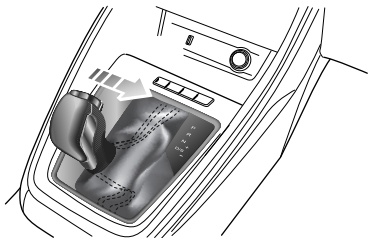

Once D is selected, move the shift lever to the right to select S and enable the Sport Mode (the gear displayed in information centre changes to "S"). Under Sport Mode, the transmission upshifts later, so as to make full use of the power reserves of the engine .

When better acceleration is required, please select the Sport Mode, but please note that the fuel consumption will be increased when driving in Sport Mode.

To exit Sport Mode, move the shift lever to the left back into D position.

### Cruise Control Mode

With the cruise control function enabled, the transmission will switch to the relevant gear for the vehicle speed automatically, thereby avoiding frequent gear shift when the system needs to maintain a constant speed.

### Manual Mode

With Sport Mode, move the shift lever toward "+" or "-", this will enable Manual Mode. The gear displayed in the information centre will indicate current gear with a single number (1 ~ 6).

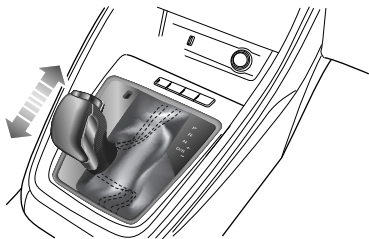

Move the shift lever toward “+” direction to upshift to next available high gear, move toward “-” direction to downshift to next available low gear.

With Manual Mode selected, if the driver makes an unreasonable gear selection, requests an upshift during low engine speeds, or requests a downshift during high engine speeds, the transmission will not respond and will remain in the current gear. If the vehicle is driven and the engine speed falls below a preset threshold in certain

gears, the transmission will automatically shift down to the next gear to avoid engine stalling; when the vehicle accelerates, if the engine speed exceeds a preset limit, the transmission will automatically shift up to the next gear to protect the engine.

With Manual mode, the information centre will provide gear shift indications, the Up or Down arrow is displayed at the right side of the gear position number, indicating to the driver to upshift or downshift when the conditions permit.

**Note:** *The gear shift operation should be carried out on the premise of ensuring your own safety and observing the traffic regulations.*

To return to Sport Mode or any other modes, shift the lever across to the left and select D.

### Automatic Transmission Failure

If the automatic transmission develops a problem, the engine emission malfunction indicator lamp in the instrument pack will illuminate or the message centre will display “EP”.

## STARTING & DRIVING

---

Some “failure modes” will cause the transmission to enter “Limp Mode”, during this time only certain gear positions can be selected and/or work, for example, R gear may not be selectable. If a serious functional failure occurs the vehicle cannot be driven, please consult an MG Authorised Repairer immediately.

***Note: When the vehicle is in ‘Limp Mode’, manual gear selection functions are disabled and therefore not available.***

### Manual Transmission \*

#### 5-speed Manual Transmission

#### Shift lever

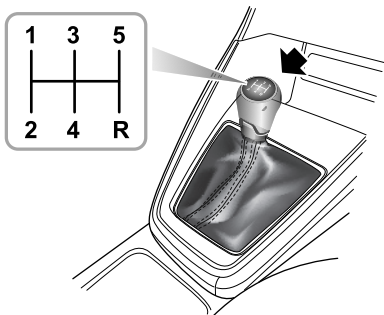

The manual transmission is a 5-speed transmission with 6 gears, which are: 1st, 2nd, 3rd, 4th, 5th, R (Reverse) respectively.

#### Precautions while driving:

- 1 When selecting R gear, you must ensure that the vehicle is completely stationary, wait for a moment and then fully depress the clutch pedal to complete the gear shift.
- 2 Do not rest your hand on the shift lever while driving - pressure from your hand may cause premature wear to the gear shift mechanism.
- 3 Do not rest your foot on the clutch pedal when driving - excessive wear to the clutch may occur.
- 4 Do not hold the car stationary on a hill by slipping the clutch. This will wear out the clutch.

# STARTING & DRIVING

---

## **Gear Shift Indications**

When the vehicle is in motion and the clutch pedal fully released, the information centre will display the currently selected gear (1-5). An Up/Down arrow is displayed to the right of the number indicating to the driver to either upshift or downshift when driving conditions permit.

## Brake System

### Foot Brake

For added safety, the hydraulic braking system operates through dual circuits. If one circuit should fail, the other will continue to function, but greater pedal pressure will be needed, and increased brake pedal travel, and longer stopping distances will be experienced. In the event of a brake failure where only one circuit is operational, the car should be brought to a halt as soon as traffic conditions safely allow. **DO NOT** continue driving - seek an MG Authorised Repairer.

### Servo Assistance

The braking system is servo assisted, always be aware of the followings during the operation:

- The servo assistance functions with the engine started up only. Never allow the car to coast with the engine turned off.
- Always take particular care when being towed with four wheels on the ground and the engine turned off. If the engine should stop for any reason while driving, bring

the car to a halt as quickly as traffic conditions safely allow, and do not pump the brake pedal as the braking system will lose any remaining servo assistance.

- Once the engine has stopped it will lose any remaining servo assistance, use suitable force to apply the brake pedal to stop the car safely in the current traffic conditions. Contact an MG Authorised Repairer.
- Efficiency of the brake servo booster can be affected by numerous conditions, such as engine speed loss. These conditions could result in extra force required to operate the brake pedal to stop the car.

### Wet Conditions

Driving through water or heavy rain may adversely affect braking efficiency. The SCS (Stability Control System) includes a Brake Disc Wiping function which is activated when the windscreen wipers are used. However, always keep a safe distance from other vehicles and intermittently apply the brake pedal in conditions where the wipers are not used.

## STARTING & DRIVING

---

### Electronic Brake Force Distribution (EBD)

Your car is equipped with Electronic Brake Force Distribution, which, in order to maintain braking efficiency, distributes braking forces between front and rear wheels, under all load conditions.

EBD integrates a monitoring system. The monitoring system is linked to the brake system malfunction indicator lamp on the instrument pack. Refer to "Warning Lamps and Indicator Lamps" in "Instruments and Controls" section.

If the indicator lamp illuminates while driving, or remains illuminated after the ignition switch is turned on (ON position) and the parking brake is released, it indicates there is a failure with the braking system, and EBD may be inoperative. In such a case, stop the car as soon as safety permits and seek an MG Authorised Repairer immediately. DO NOT drive the car with the braking system malfunction indicator lamp illuminated.

### Electronic Brake Assistance (EBA)

Your car is equipped with Electronic Brake Assist, which reacts to the speed at which the brake pedal is applied. If, in an emergency situation the brakes are applied faster than the limits set within the system, then full ABS application is applied to bring the car to a stop in the shortest possible distance.

### Hill Hold Control (HHC)



***HHC has limitations when subject to adverse conditions such as wet or icy surfaces and steep slopes.***



***HHC is not a substitute for parking brake application when carrying out a hill start. DO NOT exit the vehicle with only HHC applied, it may lead to a serious accident when HHC releases.***



***The car may roll if 'pull-away' is not achieved immediately after releasing the brake pedal.***





***Always ensure the brake pedal is pressed or parking brake applied until drive is taken up by the clutch.***



***Firm application of the brake pedal when stopping is required by HHC to generate sufficient brake pressure to maintain hold.***

Hill Hold Control is a comfort function. It works on inclines when the car detects it has come to a 'stand still status'. Once the clutch pedal has been pressed down and the brake pedal released, the vehicle will maintain pressure in the braking system for 1 – 2 seconds. After this, the Hill Hold will release.

HHC assists the driver by 'holding' the vehicle during hill starts.

The following conditions must be fulfilled to activate HHC:

- Stop the vehicle on a slope in excess of 3% and for more than 2 seconds.
- SCS is active and fault free.
- Parking brake is released.
- Clutch pedal is pressed (MT), or in D or R gear (AT).

- Ignition is ON.
- Sufficient brake pedal application force has been applied. If the driver releases the brake pedal on a hill, HHC will maintain brake pressure for 1 - 2 seconds, after this period the vehicle may roll backwards.

***Note: HHC cannot overcome physical limitations. DO NOT solely rely on HHC.***

***Note: HHC is available in both forward and backward directions when pulling away on uphill slopes.***

# STARTING & DRIVING

---

## Anti-lock Brake System (ABS)



*ABS cannot overcome the physical limitations of stopping the car in too short a distance, cornering at too high a speed, or the danger of aquaplaning, i.e. where a layer of water prevents adequate contact between the tyres and the road surface.*

The purpose of the anti-lock braking system (ABS) is to prevent the wheels from locking while braking, thereby enabling the driver to retain steering control of the car.

The fact that a car is fitted with ABS must never tempt the driver into taking risks that could affect his/her safety or that of other road users. In all cases, it remains the driver's responsibility to drive within normal safety margins, having due consideration for prevailing weather and traffic conditions.

Under normal braking conditions, ABS will not be activated. However, once the braking force exceeds the available adhesion between the tires and the road surface, thereby causing the wheels to lock, ABS will automatically

come into operation. This will be recognisable by a rapid pulsation felt through the brake pedal.

## Braking in an Emergency



***DO NOT pump the brake pedal at any time; this will interrupt the operation of ABS and may increase the braking distance.***

If an emergency situation occurs, the driver should apply full braking effort even when the road surface is slippery. ABS will ensure that the wheels do not lock and that the car is brought to a halt in the shortest possible distance for the prevailing road surface conditions.

***Note: On soft surfaces such as powdery snow, sand or gravel, the braking distance produced by the ABS system may be greater than that for a non-ABS system, even improved steering would be experienced. This is because the natural action of locked wheels on soft surfaces is to build up a wedge of material in front of (or to the side of, if steering) the tyre contact patch. This effect assists the car to stop when braking or to change direction when steering.***

No matter how hard you brake, you are still able to continue steering the vehicle as normal.

### IMPORTANT

ABS can not reliably make up for the driver's mis-operation or lack of experience.

### ABS Malfunction Indicator Lamp

Refer to "Warning Lights and Indicators" in "Instruments and Controls" section.

**Note:** *The normal (non-ABS) braking system remains fully operational and is not affected by partial or full loss of ABS. However, the braking distances may increase.*

### Emergency Braking Hazard Warning Lights Control (HAZ)

If the vehicle is travelling in excess of 31 mph (50 km/h) and the driver makes an emergency braking manoeuvre, the hazard lights will be operated to indicate this to other drivers.

**Note:** *If the hazard warning lights are being operated manually, this suspends the HAZ function.*

When the emergency braking manoeuvre is exited (no severe deceleration detected) then the function will be switched off after a few seconds.

### Active Rollover Protection (ARP)



**ARP system is just a kind of safe-assistant device, which cannot possibly surpass the physics laws to guarantee the vehicle from rollover.**

In case that the vehicle with high centre of mass due to dual-direction lane-change may roll over, ARP brakes the outside wheels to under-steer, thereby preventing the vehicle from rollover.

**Note:** *With ARP in use, the vehicle under-steers and it is normal if it fails to steer fully according to the intent of the driver during the operation of ARP.*

## STARTING & DRIVING

---

### Parking Brake



***DO NOT drive with the parking brake applied, or apply the parking brake while the car is in motion. This could result in loss of control, prevent the ABS from functioning correctly, and may even cause damage to the rear brakes.***

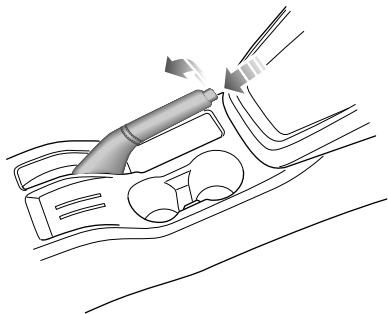

The parking brake operates on the rear wheels only. To apply the parking brake, pull the lever up. Always apply the parking brake fully whenever you park the car.

To release, pull the lever up slightly, press the button (arrowed in illustration) and fully lower the lever. When parking on a steep slope, do not rely on the parking brake alone to hold the car.

### Automated Stop/Start —Intelligent Fuel Saving System \*

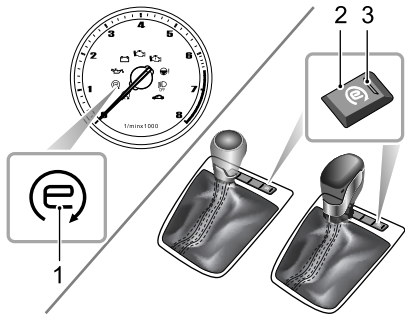

- 1 Instrument Pack Indicator
- 2 Main Switch
- 3 Switch Indicator Lamp

Engine Stop/Start has been incorporated into vehicles in an effort to reduce emissions. As the name suggests the system will allow the engine to be switched off when engine power is not required and then automatically be restarted when it is.

This system defaults “on” with the ignition switch in the ON position, the switch indication light is on (3 shown in fig ) and can be turned off by pressing the main switch (2 in the fig). The lamp in the switch will extinguish.

**Note:** *If vehicle is driving through deep water, please use Stop/Start intelligent fuel saving system main switch (2 in diagram) to shut down Stop/Start intelligent fuel saving system.*

# STARTING & DRIVING

---

## Automatic Shutdown of Engine



*Although the engine is not running after an automatic stop, the system is prepared to auto start therefore the following actions could be dangerous:*

- 1 Leaving the vehicle while the seat belt is still buckled, or there is a substitute seat belt buckle inserted.*
- 2 Carrying out work or checks in the engine compartment.*
- 3 Refuelling the vehicle, the ignition must be switched "OFF" or the key removed from the switch.*
- 4 Vehicles with automatic transmission: Leaving the vehicle while the gear selector is still in Drive position (R/D/S).*

## Engine Auto Stop Conditions

Engine Auto Stop Conditions (Under Stop Start Control, warning lamp on, figure 1 in illustration)

- Vehicle is stationary, i.e. speed =0 mph or km/h.

- The vehicle speed prior to stopping exceeded 6 mph (10 km/h).
- Vehicles with manual transmission: Gearbox must be in neutral and clutch pedal is released.
- Vehicles with automatic transmission: the gear is in D gear and the brake pedal is depressed, engine will automatically stopped. Then shift to P/N gear and release the brake pedal, the vehicle will keep the shutdown status.
- The driver's door is closed and seat belt is secured.
- The bonnet is closed.
- Transmission in Drive with footbrake pressed.(auto only)
- No demands on the steering.(auto only)

## Stop/Start Prohibited

Stop Start will not operate if:

- Coolant temperature is below a preset limit .
- Front defrost is on.
- Battery power is below a preset limit.
- The vacuum in the braking system is below a preset limit.

- Starter motor temperature is above a preset limit.
- Reverse gear selected or has been selected prior to parking.
- Heating or cooling demand is too great.
- Vehicle is standing at excessive angles.(auto only)

### Automatic Engine Start

With the engine stopped in the automatic stop/start condition, the following driver actions will cause an automatic restart, at this time the instrument pack indicator lamp is off.

- Models with automatic transmission and in D position: release the brake pedal, or shift out of Drive position..
- Models with manual transmission: Transmission in Neutral position: press the clutch pedal or accelerator pedal.
- Vehicles with automatic transmission: Release the brake pedal with the shift lever in D position, or depress the brake/accelerator pedal with the shift lever in P/N position, or shift the lever to Drive(R/D/S) position.

With the engine stopped in the automatic stop/start condition, the following actions will cause an automatic restart.

- Battery power falls below a preset limit.
- The vacuum in the braking system falls below a preset limit.
- The vehicle begins to move.
- The Stop/Start main switch is pressed.

At this time the Stop/Start fuel saving system indicator on the instrument will extinguish to indicate engine start phase. (I in figure):

### Start Inhibition

**Note:** *When a vehicle fitted with a manual transmission is under automatic Stop/Start control and the engine is required to restart, but neutral position is not selected, the engine will restart when neutral position is selected.*

If any of the following conditions occur during automatic engine stop, the engine can only be restarted using the key, during this time the instrument pack indicator will extinguish.

## STARTING & DRIVING

---

- The driver side seat belt is unbuckled.
- The driver side door is open.
- Bonnet is open.

At this time the Stop/Start fuel saving system indicator on the instrument will extinguish to indicate engine start phase.(I in figure):

### Stall Assist

Once Stop/Start intelligent fuel saving system is enabled without inhibition conditions.

If the engine cuts out, or is stalled whilst Stop/Start is enabled, selection of neutral and pressing the clutch pedal will automatically restart the engine.

**Note:** *Extremely low battery power may result in the engine not re-starting automatically, or even using the key. In this instance, external power is needed to start the engine or the battery will require re-charging. See the section 'Emergency Starting' in the 'Emergency Information' Chapter.*

### Battery



**When charging the battery, starting the car with an external power source or supplying power from the vehicle, the negative cable must be connected to a suitable position on the vehicle body. Failure to do this will result in inaccurate battery power calculation which will effect automatic Stop/Start control.**



**DO NOT disconnect the battery sensor unless absolutely necessary. removal will result in inaccurate battery power calculation which will effect automatic Stop/Start control.**

**Note:** *Failure to operate within the following guidelines will effect battery performance and automatic Stop/Start control:*

- 1 *After power interruptions (battery disconnection) the automatic Stop/Start function will be suspended until the vehicle is left in a locked state for at least 4 hours whilst the system relearns the state of the battery.*



- 2 If the vehicle is run continually for more than 100 hours uninterrupted, the Stop/Start function will be suspended until the vehicle is left in a locked state for at least 4 hours whilst the system relearns the state of the battery.*
- 3 If the battery requires replacement, ALWAYS use a genuine part to the manufacturers specification.*

*Failure to adhere to this can affect the automatic Stop/Start system.*

### **Automated Stop/Start Intelligent Fuel Saving System Failure**

In the event of a Stop/Start Intelligent Fuel Saving System failure, contact an MG Authorised Repairer.

The Stop/Start Intelligent Fuel Saving System can be effected by faults within other vehicle systems - in the event of failure contact an Authorised MG Repairer.

### **Starter Inoperative, Serious Battery Capacity Loss**

In the case of serious battery power loss, automatic Stop/Start and key start may not be possible. In this case see the section 'Emergency Starting' in the 'Emergency Information' Chapter.

# STARTING & DRIVING

---

## Stability Control System (SCS) and Traction Control System (TCS)

### Stability Control System (SCS)

SCS is designed to assist the driver in control of driving direction. The SCS is automatically activated after the engine is started.

When SCS detects that the vehicle is not moving in the intended direction, it will intervene by applying brake force to selected wheels or through the engine management system to prevent sliding and assist in bringing the car back to the right direction.

### Traction Control System (TCS)

The purpose of electronic traction control is to aid traction, thereby helping the driver to maintain control of the car in situations where one or both of the driving wheels are spinning (for example, if one wheel is on ice and the other on tarmac). The traction control system monitors the driving speed of each wheel individually. If spin is detected on one wheel, the system automatically brakes that wheel, transferring torque to the opposite,

non-spinning wheel. If both wheels are spinning, the system will reduce engine speed in order to regulate wheel rotation until traction is regained.

### Switching On/Off

SCS and TCS are automatically switched to standby when the ignition switch placed in ON position

To switch the system off, please refer to "Information Centre" in "Instruments and Controls" section.

**Note: Disabling SCS and TCS will not affect the operation of ABS. Always disable SCS/TCS when driving with snow chains fitted.**

### Stability Control/Traction Control Warning Lamps

Refer to "Warning Lights and Indicators" in "Instruments and Controls" section.

## Cruise Control System

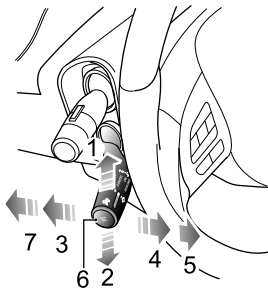

- Acceleration (1)
- Deceleration (2)
- Cruise Cancel (3)
- Cruise Standby (4)
- Cruise Resume (5)
- Cruise Set (6)
- ASL Standby (7)

Cruise control enables the driver to maintain a constant road speed without using the accelerator pedal. This

is particularly useful for motorway cruising, or for any journey where a constant speed can be maintained for a lengthy period.

### Cruise Control System Activation

Cruise control system is operated with a lever located, at the left side of the steering wheel underneath the lighting stalk switch.

With the ignition switch in position ON, if the lever switch is in the 'ASL Standby' position (7 in figure), then the cruise control is OFF. To set the cruise control to 'Standby' pull the lever switch to 'Cruise Standby' (4 in figure), the yellow indicator lamp in the instrument pack will illuminate indicating the system is in 'Cruise Standby' mode.

With the system in 'Standby' when the current vehicle speed is above 25mph (40km/h), (the operating range is 25 - 125mph (40 - 200 km/h) press the 'Cruise Set' button (6 in figure). The indicator in the instrument pack will change to green and the cruise control will enter and activated state.

The target speed of the cruise system will be set at the current speed, and the cruise system will take effect. At

## STARTING & DRIVING

---

this time, the cruise control system will maintain the set speed without pressing the accelerator pedal.

**Note:** *The set speed held in the cruise control memory will be cancelled when either the cruise control lever is switched to "ASL In Standby" position (figure 7) or the ignition switch turned off.*

### Target Cruise Speed Adjustment

When the cruise control is active, the 'target speed' can be increased or decreased:

Push the lever switch upwards (1 in figure), this will increase the speed.

Push the lever switch downwards (2 in figure), this will decrease the speed.

Release the lever switch when the desired speed is reached.

Push the lever switch upwards or downwards briefly to increase/decrease the vehicle target speed in increments of 1mph/1km/h, then the vehicle will accelerate/decelerate to the new target speed.

Pressing the accelerator at any time will override the cruise control and allow acceleration to undertake manoeuvres such as overtaking. Releasing the accelerator will return the vehicle to the set target speed.

### Pause/Stand By

Cruise control will be disengaged and set to 'Standby' if:

- Lever switch moved to 'Cruise Cancel' position (3 in figure).
- Brake pedal pressed.
- Auto gear lever moved to P, R or N.
- Manual gear-change made.
- Clutch pedal pressed.
- Conditions initiate SCS intervention.
- An incline causes excessive decline in speed.

### Resume

If the cruise control remains on after the disengagement, moving the lever switch to 'Cruise Resume' (5 in figure) will reinstate the target speed to the setting prior to disengagement.

**Note:**

- *Never use the cruise control system in the reverse gear.*
- *DO NOT use the cruise control in unsuitable conditions, such as on slippery surfaces, excessively heavy rain or in traffic conditions that DO NOT suit maintenance of constant speeds.*
- *When not in use, ensure the lever switch is in the 'ASL Standby' position (7 in figure).*
- *When the automatic transmission is in "Sport" mode, it is not recommended to use the cruise control system.*
- *During the operation of cruise control system, the actual speed may deviate from the target cruise speed to some extent due to road conditions (such as uphill, downhill, etc).*
- *If the actual speed is excessively lower than the target speed or SCS is activated due to the hill or road surfaces, the cruise control system may automatically revert to standby mode.*
- *DO NOT operate the switch for excessively long periods, or press multiple switches simultaneously,*

*this may cause the system to fail. If this situation occurs, when it is safe to do so, cycle the ignition.*

## STARTING & DRIVING

### Active Speed Limit (ASL) System

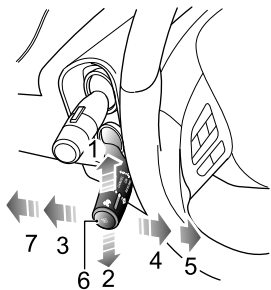

- |                         |                   |
|-------------------------|-------------------|
| 1. Speed Limit Increase | 6. Set (Activate) |
| 2. Speed Limit Decrease | 7. ASL Standby    |
| 3. Cruise Cancel        |                   |
| 4. Cruise Standby       |                   |
| 5. Cruise Resume        |                   |

The Active Speed Limit (ASL) system is designed to control the vehicle speed keeping it below a speed set by the driver.

The ASL system shares the same lever switch as the cruise control system, located to the left of the steering wheel below the indicator stalk. The switch can be toggled between both functions, however only one function can operate at any one time.

#### Activate

The desired target speed of the ASL system is displayed in the instrument information cluster, refer to "Information Centre" in the "Instruments and Controls" section. With the ignition switch in position ON and the lever switch in "ASL Standby" (7 in figure), the ASL function is in standby mode by default, briefly moving the lever switch up/down (1,2) adjusts the target speed of the ASL. The range of target speed adjustment is 20 - 130mph.

The target speed limit value will be increased or decreased by 5 mph every time the lever switch is briefly moved upwards or downwards.

Pressing the "Set" button (6 in figure) will activate the ASL system and set the speed limit. The ASL indicator lamp in the instrument pack will illuminate.

***When activated if the vehicle speed is greater than the user inputted target speed the system will immediately begin to slow the vehicle to the inputted target.***

### Kick Down

With the system active if it is necessary to accelerate the vehicle e.g. overtaking manoeuvre, the system can be overridden by pressing the accelerator pedal passed a Kick down position. The kick down position is approximately 80% of the overall accelerator pedal travel. Once the kick down position has been reached the ASL system enters a standby state and returns the vehicle operation to the user, accelerating according to the demand from the accelerator pedal.

After a kick down event, once the vehicle speed has dropped below the target speed originally controlled to, the ASL system will automatically resume and control the vehicle to the target speed retained within the system.

### Suspending ASL

When ASL is active, to suspend the feature press the "Cruise Standby" button (4) and the ASL system will exit to the standby state returning control to the accelerator pedal.

***Note: When suspended via the "Cruise Standby" button (4) the previously inputted target speed will be retained within the system memory in the case that the system is reactivated.***

### Resuming ASL

If the system has been placed in a standby state with a retained target speed the system can be reactivated to the previously stored target speed by pressing the "Set" button.

***Note: After the ignition is switched OFF, the target speed previously stored will be erased. In the interest of economy and safety, it is recommended to select different target speeds according to different driving and road conditions.***

## STARTING & DRIVING

---

### **Overshoot of Target Speed and Warning**

The system is designed to control the vehicle speed to within +/- 1.5 mph (2 km/h) of the inputted target speed. However, the feature does not incorporate vehicle braking assist, therefore if the ASL system is attempting to control vehicle speed on a steep downhill incline the inertia of the vehicle may force the vehicle speed over the intended target speed.

If at any time the vehicle speed increases 2 mph (3 km/h) more than the desired target speed the system informs the user with continuous visual and periodic audible warnings. Once the desired target speed has been maintained the warnings are removed.

**Note:** *If the target speed has been deliberately exceeded i.e. Kick Down, only a visual warning is displayed.*



### Parking Aid \*

#### Ultrasonic Sensor Parking Aid \*



*The purpose of the parking aid is to assist the driver in reversing! The sensors may not be able to detect obstacles of certain type, e.g. narrow posts or small objects no more than a few inches wide, small objects close to the ground, objects above the tailgate and some objects with non-reflective surfaces.*



*Keep the sensors free from dirt, ice and snow. If deposits build up on the surface of the sensors, their performance may be impaired. When washing the car, avoid aiming high pressure water jets directly at the sensors from close range.*

### Rear Parking Aid \*

The ultrasonic sensors in the rear bumper monitor the area behind the vehicle to search for obstacles. If any obstacle is detected, the system will calculate its distance from the rear of the vehicle and communicates the message to the driver by sounding warning chimes.

#### Parking Aid in Operation

When the ignition switch is in the ON position, the rear parking aid is enabled automatically when reverse gear is selected, it is switched off as soon as reverse gear is disengaged. A short beep is given by the parking aid within 1 second after selecting reverse gear to indicate that the system is operating normally.

The entertainment system screen will display a silhouette image of the car showing the object distance values for each sensor.

## STARTING & DRIVING

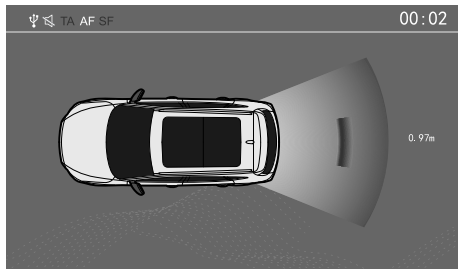

**Note: If a longer, higher pitched sound is emitted for 3 seconds when reverse gear is selected this indicates a fault in the system. In this case seek assistance from your MG Authorised Repairer.**

With the parking aid enabled, when obstacles are detected, the system will give sounds in different frequencies (there might be blind areas).

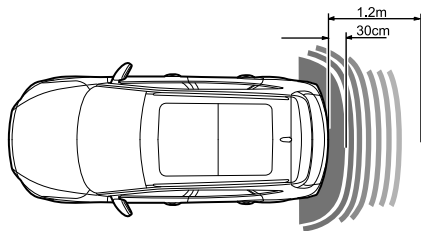

- If there is an obstacle within 1.2m range from the rear sensors, the system starts to sound. As the vehicle moves closer to the obstacle, the audible sounds are transmitted more rapidly.
- Once the obstruction is within 30cm range of the rear bumper, the audible sounds will merge into a continuous warning.

**Note:** *If the car is fitted with a tow bar, when the tow bar is connected you may experience the following symptoms:*

*Models featuring Parking Aid (and models with camera) - a warning message stating 'Rear Parking Aid System Fault' is displayed in the entertainment screen alongside the vehicle silhouette. This depicts the parking aid has a fault (this is not the case, it has only been temporarily disabled due to a towed device).*

### Parking Camera System \*



*The purpose of the parking camera system is to assist the driver in reversing! The camera has limited field of view and cannot detect obstacles outside the field of view.*

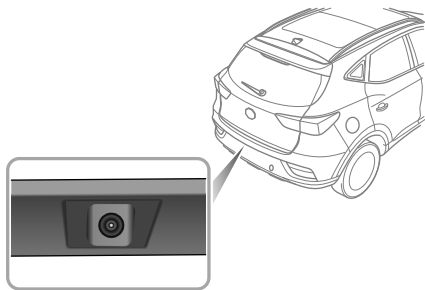

Some models have a parking camera fitted between left and right license plate lamps. When the reverse gear is selected, the camera will display an image of what is directly behind the car in the entertainment display.

## STARTING & DRIVING

---

Models fitted with the parking camera system display an overlay grid on the camera image in the entertainment display to assist parking, this is supported by the silhouette image showing object distance from each sensor.

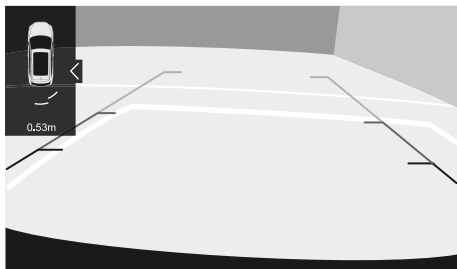

### Tyre Pressure Monitoring System (TPMS)



*TPMS cannot replace routine maintenance and check of the tyre condition or pressure.*



*If radio transmission devices such as mobile telephones or wireless headsets are used in close proximity to the vehicle it may result in interference with the TPMS and could register as a fault.*

**Note:** TPMS only gives the driver a warning when the tyre pressure is low, it will not inflate the tyre.

TPMS uses pressure sensors built into tyre valves to continuously monitor pressure and transmits signal to ECU inside the vehicle using RF signals. If it deduces that the pressure of that tyre has fallen below the predefined limit of the system, the warning light on the instrument pack will illuminate (always yellow). For more information, please refer to 'Instrument Pack' in 'Instruments and Controls' section. Check your tyres at the earliest opportunity and

reinflate to the correct pressure. Please refer to 'Tyre Pressure (Cold)' in 'Technical Data' section.

### System Malfunction



This system is self-monitoring, if a malfunction is detected, the TPMS warning lamp (yellow) on the instrument pack will flash for 90 seconds first and then illuminate.

**Note:** When a puncture is detected, the system will require some time to analyse information prior to illuminating the warning lamp.

Under certain conditions the warning light may illuminate when a fault is not present, these conditions include:

- A non recommended tyre fitted (including spare tyre).
- Rough terrain driving for excessive periods.
- Bending or mountain type terrain driving for excessive periods.
- TPMS will not respond immediately if a tyre 'blows out'.

# STARTING & DRIVING

---

## TPMS Self-learning

The TPMS system is a 'self learning' system, after resetting tyre pressures it will be necessary to allow the system to go through a self learning process. This is done by driving the car, during this process the system is suspended and the data displayed may not be correct. If sensors or receiver module are replaced the system requires programming, consult an MG Authorised Repairer. If the wheels are swapped or rotated the system requires reprogramming to learn the new transmitter positions, consult an MG Authorised Repairer.

### Load Carrying



**DO NOT** exceed the gross vehicle weight or the permitted front and rear axle loads. Failure may result in vehicle damage or serious injury.

### Loadspace Loading



Ensure that the rear seat backrests are securely latched in the upright position when loads are carried in the load space behind the seats.



If the tailgate can not be closed due to the type of cargo loaded, be sure to close all windows during driving, select the face distribution mode of the air condition, and set the blower to maximum speed, so as to decrease exhaust fumes entering the vehicle.

When luggage is carried in the load space, always ensure heavy items are placed as low and as far forward as possible,

so as to avoid the cargo shift in the event of an accident or sudden stop.

Drive carefully and avoid emergency braking or manoeuvres.

Driving with the tailgate open is very dangerous. If the load being carried requires the tailgate to be open, please ensure the cargo is suitably secured and every measure is taken to prevent exhaust fumes entering the vehicle.

#### IMPORTANT

Traffic regulations must be observed when loading cargo, if the cargo extrudes the loadspace appropriate warning measures must be taken to warn other road users.

### Internal Loading



**DO NOT** carry unsecured equipment, tools or luggage that could move, causing personal injury in the event of an accident, or emergency braking or hard acceleration.

## STARTING & DRIVING

---



**DO NOT obstruct the driver's or passenger's vision with loads.**

Folding the rear seats can increase luggage space, refer to “Rear Seats” described in the “Seats and Restraints” section.

When cargo is loaded in the vehicle, place it at a position as low as possible and ensure that it is tightly secured, so as to avoid personal injury caused by cargo movement when traffic accidents or emergency braking occurs. If the cargo has to be placed on a seat, then the seat must not be used by an occupant during that time.

### General Towing Safety

Your vehicle can tow a trailer if you carefully observe load limits, use approved equipment, and follow the towing guidelines. Always check load limits before towing.

Towing loads in excess of the maximum towing weight can seriously affect vehicle handling and performance, and could damage your vehicles engine and drive-train.

**Note: Exceeding any load limits advised by MG Motor UK Ltd is dangerous. Consult the recommended load limits and loading prior to any journey.**

**Check the loading of your vehicle and trailer carefully before starting to drive.**

Trailer hitch load should never exceed the limit advised by MG Motor UK Ltd.

**Note: Excessive towing loads reduce front tyre traction and steering control, too little trailer nose load can make the trailer unstable and cause it to sway.**

**Tow bars:** Only genuine MG approved tow bars should be fitted to your vehicle. Only use the attachment method specified by the vehicle manufacturer for securing the



towing hitch. Contact your authorised MG dealer for more information.

**Safety chains:** Safety chains must be used as a precautionary measure should the trailer become unintentionally unhitched. Make sure the safety chain is securely attached to both the trailer and the vehicle prior to departure.

**Altitude:** Your engine delivers less power at higher altitude. If you tow a trailer in a mountainous area you should reduce the combined vehicle and trailer weight by 10% for every 1000m of elevation.

**Gradients:** Where possible, when towing, you should plan your journey to avoid steep gradients. The advised brake towing mass stated assumes a maximum gradient capability of 12% where possible it is recommended you drive on gradients less than 12%. Follow the trailer associations recommendations for suitable roads.

**Running in period:** Avoid towing a trailer during your vehicles first 1000 km or 625 miles.

**Stop/Start function:** Turn off Automated Stop/Start function when towing just use. The trailer weight can affect

your vehicles braking efficiency if Automated Stop/Start is activated on a hill while towing a trailer.



## **Emergency Information**

---

*220 Hazard Warning Devices*

*221 Emergency Starting*

*223 Vehicle Recovery*

*228 Tyre Repair and Wheel  
Replacement*

*236 Fuse Replacement*

*243 Bulb Replacement*

# EMERGENCY INFORMATION

---

## Hazard Warning Devices

### Hazard Warning Lights

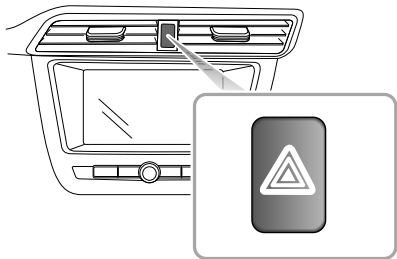

**Note:** Before you stop or slow the car in an emergency, always press the hazard warning switch. All the direction indicators will flash together to warn other road users when your car is causing an obstruction or is in a hazardous situation. Remember to switch off before driving away.

## Warning Triangle

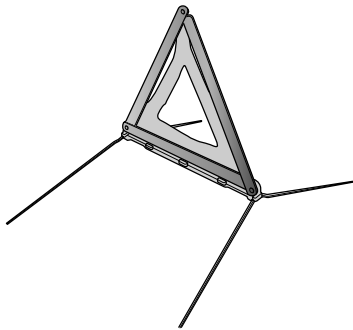

The warning triangle supplied with your car is stowed in the loadspace.

If you have to stop your car on the road in an emergency, you must place a warning triangle approximately 50 - 150 metres behind the car, if possible, to warn other road users of your position.

### Emergency Starting

#### Using Booster Cables



**NEVER** start the engine by pushing or towing.



Make sure that **BOTH** batteries are of the same voltage (12 volts), and that the booster cables are approved for use with 12 volt car batteries.



Ensure sparks and naked lights are kept well away from the engine compartment.

Using booster cables (jump leads) from a donor battery, or a battery fitted to a donor vehicle, is the only approved method of starting a car with a flat battery.

If the battery from a donor vehicle is to be used, the vehicles should be parked with their battery locations adjacent to one another. Ensure that the two vehicles do not touch.

#### Starting the Car



Ensure that each booster cable connection is securely made. There must be no risk of the clips accidentally slipping from the battery terminals (as a result of engine vibration, for example), this could cause sparking, which could lead to fire or explosion.

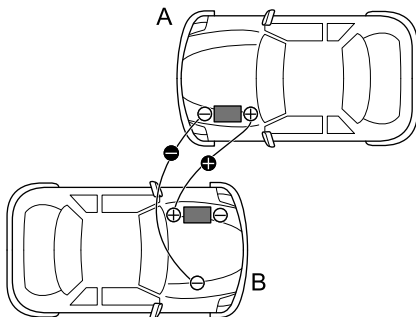

## EMERGENCY INFORMATION

---

Remove the ignition key and switch off ALL electrical equipment of BOTH vehicles, then follow the instructions below:

- 1 Connect the RED booster cable between the positive (+) terminals of both batteries. Connect the BLACK booster cable from the negative (-) terminal of the donor battery (A) to a good earth point (an engine mounting or other unpainted surface, for example), at least 0.5 m from the battery and well away from fuel and brake lines on the disabled vehicle (B).
- 2 Check that the cables are clear of moving parts of both engines, then start the engine of the donor vehicle and allow it to idle for a few minutes.
- 3 Now start the engine of the vehicle with the discharged battery (DO NOT crank the engine for more than 10 seconds). If the disabled vehicle will not start after several attempts, it may need to be repaired. Please contact the MG Authorised Repairer.
- 4 After both the vehicles have normally started, allow the engines to idle for more than 2 minutes before

shutting down the engine of the donor vehicle and disconnecting the jumper cables.

IMPORTANT
NEVER turn on any electrical equipment on the started vehicle before removing the booster cables.

- 5 Disconnecting the booster cables must be an exact reversal of the procedure used to connect them, i.e. disconnect the BLACK cable from the earth point on the disabled vehicle FIRST.

## Vehicle Recovery

### Towing for Recovery

#### Towing Eye



**DO NOT** use a tow rope that is twisted - any untwisting force could unscrew the towing eye.

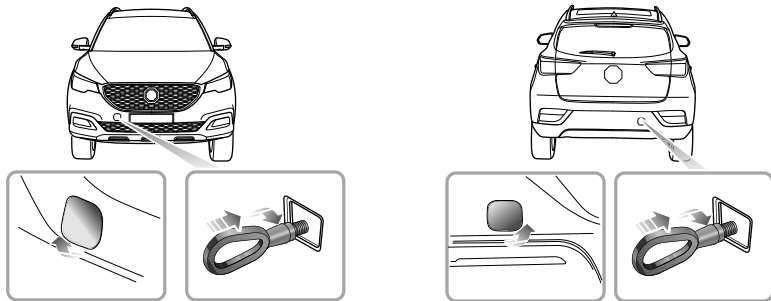

## EMERGENCY INFORMATION

---

Your car is equipped with a removable towing eye, that can be used at the front or the rear of your vehicle. The towing eye is stored in the tool kit beneath the loadspace floor when not in use.

To fit the towing eye, remove the small cover set into the bumper by pressing firmly on the bottom left corner, then screw the towing eye into its mounting behind the bumper (see illustration). Ensure the towing eye is fully tightened.

**Note:** *The towing eye cover may be secured to the bumper by a plastic cord.*

Both towing points are intended for use by qualified recovery specialists to assist in the recovery of your car when a breakdown or accident occur. They are not designed for towing other vehicles, and must NEVER be used to tow a trailer or caravan. The car can be towed by using a soft rope, but a hard rod is preferred.

### Towing for Recovery



***If, due to an electrical fault, potential safety hazards may exist, it is not allowed to put the ignition switch in the ON position.***



***When towing, DO NOT suddenly accelerate or brake suddenly, this can cause accidents.***

### Suspended Towing

If your car needs to be towed, most qualified recovery specialists will use wheel lift equipment to suspend the front wheels, while the rear wheels remain on the ground. Ensure the parking brake is released, the hazard warning lamps are activated and no passengers are left in the vehicle.



## EMERGENCY INFORMATION

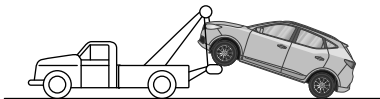

### Four-Wheel Touchdown Towing



**The towing speed of a vehicle must not exceed 20 mph (30 km/h), the towing distance shall not exceed 30 miles (50 km).**

If vehicle is towed with the four wheels on the ground, observe the following precautions:

- 1 Switch the ignition to the ON position to enable the brake lights, wipers and direction indicators to be

operated if necessary. If, due to an electrical fault, it is considered unsafe to switch the ignition on, the car will need to be recovered on a trailer.

- 2 Place the shift lever in N position (manual transmission), or in N position (automatic transmission).
- 3 Release the parking brake.
- 4 Turn on the hazard warning lamps.
- 5 If the transmission is damaged or has a lack of lubricating oil, DO NOT tow the vehicle with four wheels on the ground.
- 6 DO NOT tow backward with front wheels (drive wheels) on the ground.

## EMERGENCY INFORMATION

### Transporter or Trailer with Rope

If your car is to be transported on the back of a trailer or transporter, it must be secured as illustrated:

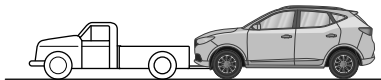

Without the engine running, greater effort will be required to operate the brake pedal and turn the steering wheel. Longer stopping distances will also be experienced.

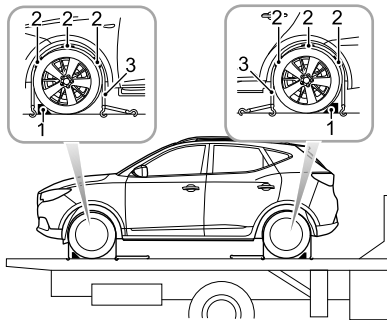

Position the car on the trailer, apply the parking brake, and place the shift lever in N position (manual transmission), or in P position (automatic transmission). Place the wheel chock (1) as shown in the figure, then place the anti slip rubber pad (2) around the circumference of the tyre.

## EMERGENCY INFORMATION

---

Fit the lashing straps (3) around the wheels and secure to the trailer. Tighten the straps until the car is securely held.

# EMERGENCY INFORMATION

## Tyre Repair and Wheel Replacement

### Tool Identification

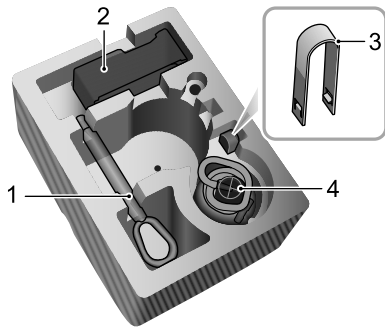

- 1 Towing Hook
- 2 Electric Air Pump
- 3 Wheel Bolt Cap Removal Tool
- 4 Repair Fluid Reservoir

### Tyre Repair

- 1 Remove the label at the bottom of the repair fluid reservoir and attach it to the steering wheel to remind the driver not to exceed 50 MPH (80 km/h).

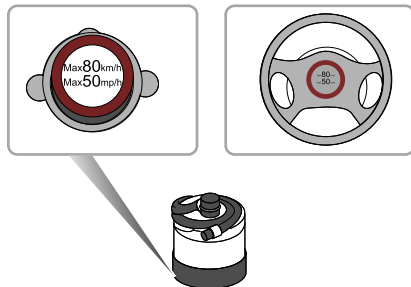

- 2 Connect the air hose of the electric air pump to the repair fluid reservoir, fit the tyre sealant bottle (upright) into the slot on the compressor. Remove the valve dust cap of the flat tyre, and connect the filler hose from the tyre sealant bottle to the tyre

## EMERGENCY INFORMATION

valve. Ensure that the power switch of the electric air compressor is switched off (i.e., press "O"), then insert the plug from the compressor into the centre console power socket, and turn the ignition switch to the position "ON/RUN/START".



**Note:** To avoid battery discharge, it is recommended to keep the engine running.

- 3 Switch on the power switch of the electric compressor (i.e., press "-"), to start pumping sealant into the tyre. The tyre sealant bottle will become empty after approximately 30 seconds. The tyre should reach the specified pressure within 5 or 10 minutes.

**Note:** The pressure gauge may briefly reach 6 bar (87 psi), then the pressure begins to drop to normal.

- 4 When the required pressure is reached, switch off the power switch of the electric compressor (i.e., press "O").

**Note:** If the required pressure cannot be reached within 10 minutes, please disconnect the compressor, drive the vehicle 10 metres (33 feet) approx forward or backward to allow the sealant to spread within the tyre. If the required pressure can still not be reached, the tyre is severely damaged and you should seek assistance from the MG Authorised Repairer.

## EMERGENCY INFORMATION

**Note:** *Consecutive operation of Electric air compressor for more than 10 minutes may result in damage to the compressor.*

**Note:** *Under no circumstances should you continue your journey with a deflated tyre. Driving a vehicle with a deflated tyre is extremely dangerous.*

- 5 Remove the tyre sealant bottle from the slot in the compressor, disconnect the hose from the tyre valve, remove the compressor plug from the centre console power socket, return the tyre repair kit to its stowage tray.
- 6 After successfully adding sealant to the tyre, drive immediately for a short time (around one minute) this will allow the sealant to distribute evenly inside the tyre. Continue driving and do not exceed 50 MPH (80 km/h). After a further 10 minutes, find a safe place to stop and recheck the tyre pressure.

Please take different measures based on the tyre pressure measured:

- If the tyre pressure has dropped to less than 0.8 bar (11.6 psi), do not continue driving, seek assistance instead.
- If the tyre pressure is between 0.8 bar (11.6 psi) and specified pressure, connect the hose of electric air pump to the tyre valve, and connect the plug of the electric air pump to the power socket, then switch on the electric air pump to inflate the tyre until it reaches the specified pressure. Repeat the operations of step 6 after driving a maximum distance of 3 miles (5 km).

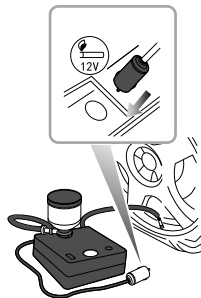

## EMERGENCY INFORMATION

- If the tyre pressure has not dropped, you may continue driving, but the vehicle speed must not exceed 50 MPH (80 km/h), and the driving mileage must not exceed 125 miles (200 km).

**Note:** **DO NOT** remove foreign objects (eg. screws, nails) from the tyre. The tyre repair system must only be used when the foreign object is in the tread pattern (A), **DO NOT** attempt a repair when the damage is in the sidewall of the tyre (B).

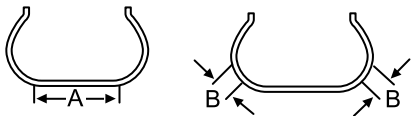

### Spare Wheel and Tool Kit\*

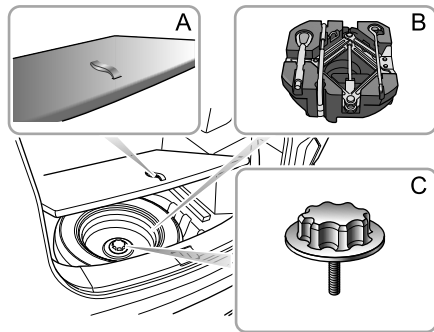

#### Spare Wheel and Tool Kit Removal

- 1 Lift the luggage carpet (A) with the lifting strap.
- 2 Remove the tool tray (B).
- 3 Unscrew the spare wheel retaining nut (C) and lift the wheel from the storage space.

## EMERGENCY INFORMATION

---

**Note:** A spare wheel kit is not standard issue equipment, it will only be available as an accessory from an MG Authorised Repairer.

### Spare Wheel Replacement Tool

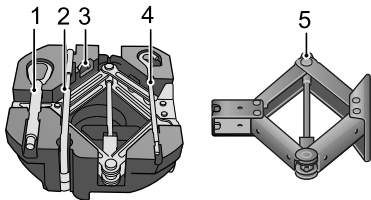

- 1 Towing hook
- 2 Wheel bolt spanner
- 3 Wheel bolt cap removal tool
- 4 Jack handle
- 5 Jack

### Changing a Wheel \*

If you need to change the wheel during the journey, choose a safe place to stop away from the main road if possible. Always ask your passengers to get out of the car and wait in a safe area away from other traffic.

Switch on hazard warning lamps. If available, position a warning triangle about 50 to 150 metres behind your vehicle to warn approaching traffic.

Before changing a wheel, ensure the front wheels are in the straight ahead position. Apply the parking brake and place the gear shift lever of transmission in N position.

Observe the following precautions:

- Ensure the jack is positioned on firm, level ground.
- If the vehicle must be parked on the hill, place chocks in front of and behind other 3 wheels to prevent the vehicle moving.



## EMERGENCY INFORMATION

### Positioning the Jack



**NEVER** work beneath the car with the jack as the only means of support. The jack is designed for wheel changing only!



**NEVER** jack the car using any jacking points other than the jacking points. Serious damage to the car could result.

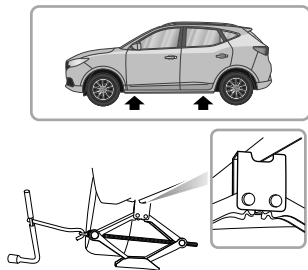

**Avoid accidental contact with any underbody parts, especially hot exhaust system components.**

Position the jack on firm level ground under the jacking point nearest the wheel to be removed. Note that the domed head of the jack must fit into the corresponding recess in the sill plate (There is a triangle indicator in the area shown by the arrowhead. See the illustration above).

Turning the jack screw by hand, adjust the jack until the jack head fits snugly onto the sill in the correct area. Ensure that the base of the jack is in full contact with the level ground.

### Fitting the Spare Wheel



**Regularly check the spare wheel tyre pressure, it may not be used for long periods of time. After fitment, at the first opportunity check and adjust the tyre pressure.**



**The wheel bolts must be tightened to the specified torque after changing a wheel (115 ~ 130 Nm).**

## EMERGENCY INFORMATION

---

- 1 Before raising the car, use the special tool supplied with the vehicle to remove each wheel bolt cap. Use the wheel bolt spanner to slacken each bolt half a turn anti-clockwise.
- 2 Turn the handle in a clockwise direction until the tyre is clear of the ground.
- 3 Remove the wheel bolts and place them in the tool tray to prevent them from being lost. Make sure the vehicle is steady and there is no risk of slip or movement before removing wheel bolts.
- 4 Remove the road wheel.

**Note:** *Avoid placing wheels face down on the ground - the surface may be scratched.*

- 5 Fit the spare wheel and tighten the wheel bolts with wheel bolt spanner until the wheel is seated firmly against the hub.
- 6 Lower the car and remove the jack, then FULLY tighten the wheel bolts in a diagonal sequence.
- 7 Finally, return the tools to the toolbox, put the toolbox into the well of the boot floor, tighten the spare wheel

retaining nuts, and put the replaced wheel above the toolbox in the well in the load space floor (face down). Lower the boot floor, and put the boot storage box on the boot floor.

**Note:** *DO NOT stand on the handle of the wheel bolt spanner or use extension tube on the handle of the spanner.*

**Note:** *When replacing the wheel, please fully tighten the bolts in the diagonal sequence twice.*

**Note:** *Consult your MG Authorised Repairer or tyre specialist for a replacement tyre, as soon as possible.*

### Spacesaver Spare Wheel



**Only one spacesaver spare wheel can be used at any one time, otherwise the operational performance and brake performance may be reduced, thereby leading to accident or injury to yourself and others.**



*When driving on icy or slippery surfaces it is advised to fit the spacesaver wheel to the rear of the vehicle to maintain adequate stability. This may mean swapping a front wheel with a rear wheel.*



*Snow chains can not be used on the spacesaver spare wheel, this can cause damage to the car and snow chain.*

When the spacesaver spare wheel is fitted, the vehicle speed should not exceed 50 MPH (80 km/h). Please have the full-scale tyre repaired and replace the spare wheel as soon as possible. This will extend the life span of the spare wheel for other emergencies.

**Note:** *DO NOT use an automatic car wash when the spacesaver wheel is fitted, the guide rails of the car wash may conflict with the wheel/tyre and cause damage.*

# EMERGENCY INFORMATION

## Fuse Replacement

### Fuse

Fuses are simple circuit breakers which protect the vehicle electrical equipment by preventing the electrical circuits from being overloaded. A blown fuse indicates that the item of electrical equipment it protects stops working.

Check a suspect fuse by removing it from the fuse box and looking for a break in the wire inside the fuse.

The mounting location and rating of each fuse in engine compartment fuse box is shown on the label printed on the fuse box cover.

It is recommended to have spare fuses in the vehicle, which can be obtained from a local MG authorized repairer.

### Healthy and Blown Fuses

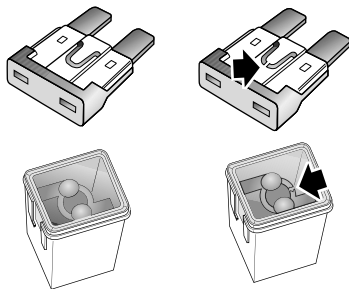

#### IMPORTANT

- NEVER attempt to repair a blown fuse. ALWAYS replace a fuse with one of the same rating.
- If a replaced fuse fails immediately, please contact an MG Authorised Repairer as soon as possible.

# EMERGENCY INFORMATION

## Fuse Box

There are two fuse boxes in the vehicle :

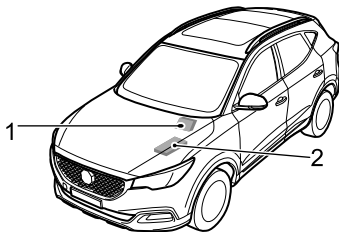

- 1 Passenger Compartment Fuse Box ( below the glove box at the front passenger side )
- 2 Engine Compartment Fuse Box ( at the left side of the Engine Compartment ) .

## Passenger Compartment Fuse Box

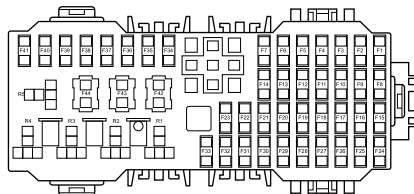

## Check or Replace a Fuse

- 1 Switch off the ignition switch and all electrical equipment, disconnect the battery negative cable.
- 2 Remove the closing panel below the glove box to gain access to the fuse box.

## EMERGENCY INFORMATION

- 3 Press the fuse extraction tool onto the fuse head and pull to remove the fuse. A blown fuse can be recognised by a break in the wire.
- 4 Replace the blown fuse with a same rating.

### Fuse Specification

NO.	Specs	Function
F1	15A	Rear wash realy
F2	10A	Rearview mirror switch, Diagnostic Socket
F3	5A	Gear shift display
F4	15A	Front wash relay
F5	10A	Airbag ECU
F6	10A	Brake pedal switch
F7	15A	Super lock relay
F8–F14	-	-
F15	15A	Front power socket

NO.	Specs	Function
F16	5A	Radio
F17	5A	Front interior lamp, Blower relay
F18	30A	Rear left window lift switch
F19	30A	Passenger window lift switch
F20	30A	Rear right window lift switch
F21	30A	Driver door switch pack
F22	10A	Door mirror heater
F23	25A	Rear window heating element
F24	15A	Radio/FICM, DAB, ICE panel switch
F25	10A	MTC, ETC, ETC panel
F26	5A	Instrument pack
F27	10A	Automatic transmission (4AT & 6AT)

# EMERGENCY INFORMATION

NO.	Specs	Function
F28	-	-
F29	-	-
F30	5A	Ignition switch
F31	10A	TPMS
F32	5A	IMMO Antenna
F33-44	-	-

## Engine Compartment Fuse Box

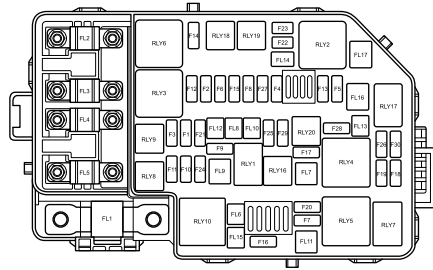

## EMERGENCY INFORMATION

### Check or Replace a Fuse

- 1 Switch off the ignition switch and all electrical equipment, disconnect the battery negative cable.
- 2 Press the locating clips to remove the fuse box lid.
- 3 Press the fuse extraction tool onto the fuse head and pull to remove the fuse. A blown fuse can be recognized by a break in the wire.
- 4 Replace the fuse with a same rating.

### Fuse Specification

NO.	Specs	Function
FL1	200A	Alternator
FL2	80A	EPS
FL3	40A	Cooling fan relay pack
FL4	60A	Passenger compartment fuse box fuse F18, F19, F20, F21

NO.	Specs	Function
FL5	80A	Passenger compartment fuse box fuse F1, F2, F3, F4, F5, F6, F7, F24, F25, F26, F27, F28, F29, F30, F31, Rear windscreen heater relay
FL6	25A	SCS ( Valve )
FL7	-	-
FL8	20A	BCM
FL9	40A	SCS ( Pump )
FL10	25A	BCM
FL11	30A	Blower relay
FL12	-	-
FL13	30A	Starter relay
FL14	25A	-
FL15	30A	KLR relay



## EMERGENCY INFORMATION

NO.	Specs	Function
FL16	30A	DC/DC
FL17	30A	-
F1	10A	Right dipped beam, Headlamp leveling switch, Right headlamp leveling motor
F2	15A	Alternator, Pre oxygen sensor, Post oxygen sensor, Variable valve timing valve (Intake, 1.0T), VVT valve (Exhaust, 1.0T), Canister control valve (1.0T), Oil control valve (1.0T)
F3	10A	Left dipped beam, Left headlamp leveling motor
F4	10A	A/C Compressor Clutch Relay
F5	5A	Engine ECU
F6	10A	Fuel injector ( 1.5L )

NO.	Specs	Function
F7	30A	Front wiper enable relay, Front wiper speed relay
F8	5A	Cooling fan relay pack, AC pressure switch, NTS
F9	15A	Fuel pump relay
F10	10A	Right main beam
F11	10A	Left main beam
F12	30A	Ignition coil, Engine ECU
F13	10A	Horn relay
F14	30A	-

## EMERGENCY INFORMATION

NO.	Specs	Function
F15	10A	Intake camshaft solenoid ( 1.5L ) , Exhaust camshaft solenoid ( 1.5L ) , Canister control valve ( 1.5L ) , Clutch position sensor ( 1.5L ) , Waste gate control valve ( 1.0T ) , Electronic thermostat ( 1.0T ) , Water pump ( 1.0T ) , Variable dump valve ( 1.0T )
F16	15A	Rear wiper relay
F17	15A	Front fog relay
F18	5A	Airbag ECU
F19	5A	Engine ECU
F20	5A	Engine ECU
F21	5A	BCM
F22	10A	-

NO.	Specs	Function
F23	10A	-
F24	5A	-
F25	10A	BCM
F26	15A	-
F27	15A	BCM
F28	15A	-
F29	10A	-
F30	10A	DC/DC, Instrument pack, ETC, Reverse lamp switch, 6AT gear shift, PAB display

## Bulb Replacement

### Bulb Specification

Lamp Bulb	Specifications
Headlamp High/Low Beam	HB3LL 60W
Front Direction Indicators	PY21W 21W
Front Fog Lamps	H8 35W
Front Side Light/Daytime Running Lamp	LED
Reverse Lamps	W16W 16W
Rear Fog Lamps	P21W 21W

Lamp Bulb	Specifications
Rear Side Light	W5W 5W
Stop Lamp/Rear Side Light	W21/5W 21/5W
License Plate Lamps	W5W 5W
Rear Direction Indicators	WY16W 16W
High Mounted Stop Lamp	LED
Interior Lamp	W5W 5W
Load Space Lamp	C10W 10W

**Note:** Bulb HB3LL is consistent with Bulb HB3 in shape and structure, and is only superior in reliability and service life.

**Note:** MG only recommends replacement bulbs that completely meet the manufacturers specifications.

# EMERGENCY INFORMATION

---

## Bulb Replacement

Before replacing any bulb, turn off the lighting switch to avoid any possibility of a short circuit.

**Note:** *Only replace bulbs with the same type and specification.*

Take care NOT to touch the glass with your fingers; always use a cloth to handle the bulb. If necessary, clean the glass with methylated spirits to remove fingerprints.

If in doubt, when replacing bulbs, contact an Authorised MG Repairer.

For other bulbs not listed and to be replaced, ask an MG Authorised Repairer for help.

## High/Low Beam Headlamp Bulb Renewal

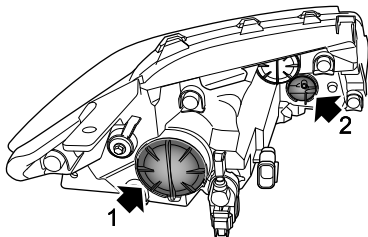

- 1 Open the bonnet—see “Bonnet” in the “Maintenance” section.
- 2 Disconnect the battery negative terminal.
- 3 Identify and locate the headlamp bulb cover plug ( 1 ).
- 4 Rotate the cover anti-clockwise and remove the cover plug.
- 5 Rotate the bulb anti-clockwise and remove.
- 6 Remove the wiring connector from the bulb.
- 7 Refit the wiring connector to the bulb.

- 8 Locate the bulb in the lamp, rotate clockwise until fully secured.
- 9 Locate the cover plug, rotate clockwise until fully secured.
- 10 Connect the negative battery terminal.
- 11 Test headlamp operation.
- 12 Close the bonnet—see “Bonnet” in the “Maintenance” section.

# EMERGENCY INFORMATION

---

## Front Direction Indicator Bulb Renewal

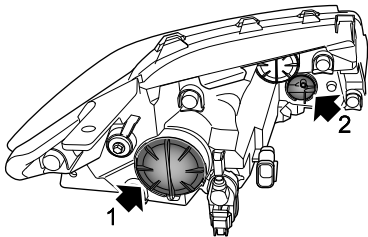

- 1 Open the bonnet—see “Bonnet” in the “Maintenance” section.
- 2 Disconnect the battery negative terminal.
- 3 Identify and locate the front indicator bulb cover plug ( 2 ).
- 4 Rotate the cover anti-clockwise and remove the cover plug.
- 5 Rotate the bulb holder anti-clockwise and remove.
- 6 Remove the bulb from the holder.
- 7 Install the bulb into the holder.
- 8 Locate the bulb holder in the lamp, rotate clockwise until fully secured.
- 9 Locate the cover plug, rotate clockwise until fully secured.
- 10 Connect the negative battery terminal.
- 11 Test lamp operation.
- 12 Close the bonnet—see “Bonnet” in the “Maintenance” section.

### Rear Stop/Tail Lamp Bulb Renewal

- 1 Open the tailgate.
- 2 Disconnect the battery negative terminal.
- 3 Using a suitable pry bar or lever, carefully release and remove the securing screw cover trim.
- 4 Using a suitable 10 mm spanner/socket wrench, remove the 2 screws securing the lamp to the body.
- 5 Release the lamp assembly and remove away from the body.
- 6 Rotate the bulb holder (1) in an anti-clockwise direction.
- 7 Remove bulb holder and remove bulb.
- 8 Fit bulb to bulb holder.
- 9 Insert bulb holder in lamp assembly, rotate clockwise until fully secure.
- 10 Ensure lamp seal is correctly located.
- 11 Position lamp to body, start both screw fixings, tighten to 3-5 Nm.
- 12 Refit screw cover trim.
- 13 Reconnect battery negative terminal.
- 14 Test lamp operation.
- 15 Close tailgate.

## EMERGENCY INFORMATION

---

### Rear Direction Indicator Bulb Renewal

- 1 Open the tailgate.
- 2 Disconnect the battery negative terminal.
- 3 Using a suitable pry bar or lever, carefully release and remove the securing screw cover trim.
- 4 Using a suitable 10 mm spanner/socket wrench, remove the 2 screws securing the lamp to the body.
- 5 Release the lamp assembly and remove away from the body.
- 6 Rotate the bulb holder (2) in an anti-clockwise direction.
- 7 Remove bulb holder and remove bulb.
- 8 Fit bulb to bulb holder.
- 9 Insert bulb holder in lamp assembly, rotate clockwise until fully secure.
- 10 Ensure lamp seal is correctly located.
- 11 Position lamp to body, start both screw fixings, tighten to 3-5 Nm.
- 12 Refit screw cover trim.
- 13 Reconnect battery negative terminal.
- 14 Test lamp operation.
- 15 Close tailgate.



### Secondary Stop Lamp (Lamp Located in Tailgate) Bulb Renewal

- 1 Open the tailgate.
- 2 Disconnect the battery negative terminal.
- 3 Using a suitable pry bar or lever, carefully remove the cover trim.
- 4 Using a suitable 10 mm spanner/socket wrench, remove the 3 screws (1) securing the lamp to the tailgate. Release the lamp assembly and remove away from the body.

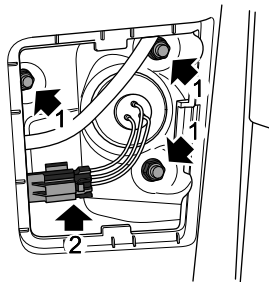

- 5 Rotate the bulb holder (2) in an anti-clockwise direction.

## EMERGENCY INFORMATION

---

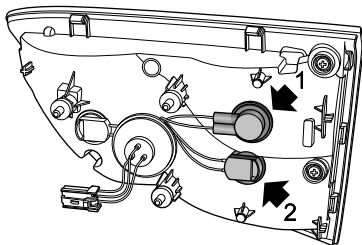

14 Close tailgate.

- 6 Remove bulb holder and remove bulb.
- 7 Fit bulb to bulb holder.
- 8 Insert bulb holder in lamp assembly, rotate clockwise until fully secure.
- 9 Ensure lamp seal is correctly located.
- 10 Position lamp to tailgate, refit the screw fixings, tighten to 3-5 Nm.
- 11 Refit screw cover trim.
- 12 Reconnect battery negative terminal.
- 13 Test lamp operation.

### License Plate Lamp Bulbs Renewal

- 1 Disconnect the battery negative terminal.
- 2 Using a suitable pry bar or lever, insert the tool between the lamp lens and rear bumper lamp aperture (protect the paintwork using masking tape and use the N/S gap).
- 3 Carefully lever the lamp out of the aperture.
- 4 Release the bulb from the bulb holder.
- 5 Insert the new bulb in the lamp bulb holder.
- 6 Position the lamp in the bumper lamp aperture, push until fully secured.
- 7 Connect battery negative terminal.
- 8 Test lamp operation.

### Side Repeater Bulb Renewal (Mirror)

Bulb not available separately, lamp assembly required.

- 1 Remove the door mirror glass by manually tilting the glass upwards, use a suitable plastic lever at the base of the glass and lever outwards releasing the glass

retaining clips (take great care not to damage the paint work).

- 2 Disconnect the electrical connector and remove the exterior door mirror glass.
- 3 Release the 2 clips fixing the cover onto the exterior door mirror assembly.

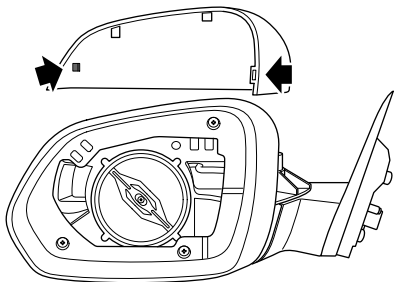

- 4 Remove the exterior mirror cover.

## EMERGENCY INFORMATION

---

- 5 Remove 2 screws (1) securing the side direction indicator lamp onto the exterior door mirror assembly.

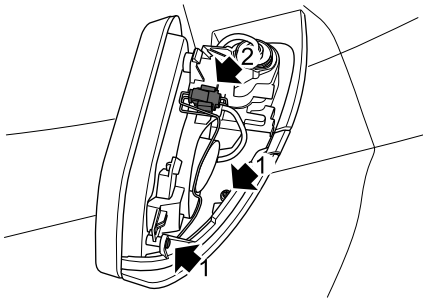

- 6 Disconnect the connector (2) and remove the side direction indicator lamp.
- 7 Remove the rubber bulb holder from the lamp assembly ( pull from lamp ).

- 8 Remove bulb from holder.
- 9 Fit bulb to bulb holder-push fit.
- 10 Position bulb holder into lamp assembly and push fully into position.
- 11 Position the lamp assembly on the exterior door mirror assembly, fit and tighten 2 screws.
- 12 Reconnect the electrical connector.
- 13 Locate the exterior door mirror cover on the mirror assembly, carefully push the cover until it clips to place.
- 14 Reconnect the electrical connectors to the door mirror glass.
- 15 Position the glass onto the exterior door mirror motor body.
- 16 Using even hand pressure, press the glass onto the motor until it clips into place.
- 17 Refit the exterior mirror glass.

### Interior Lamp Bulb Renewal

5 Test lamp operation.

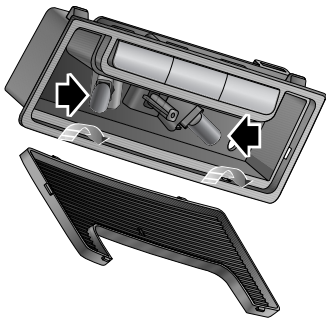

- 1 Disconnect the battery negative terminal.
- 2 Use a suitable tool or small flat bladed screwdriver to gently prise front end of the lens, and remove the lens.
- 3 Remove the old bulb and fit the new bulb to the bulb holder.
- 4 Connect battery negative terminal.

# EMERGENCY INFORMATION

---

## Load Space Lamp Bulb Renewal

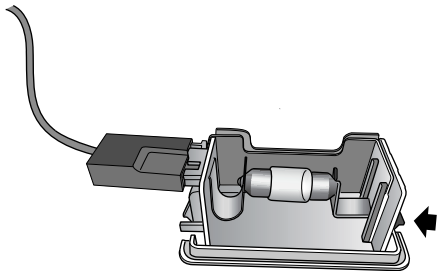

- 1 Disconnect the battery negative terminal.
- 2 Insert a suitable tool or small flat bladed screwdriver into the indent on one of the narrow sides of the lens and carefully remove the unit from its location.
- 3 Remove the old bulb and fit the new bulb to the bulb holder.
- 4 Connect battery negative terminal.
- 5 Test lamp operation.

## **Maintenance**

---

256 *Maintenance*

260 *Bonnet*

262 *Engine Compartment*

264 *Engine*

267 *Cooling System*

269 *Brake*

271 *Battery*

273 *Washers*

275 *Wipers*

278 *Tyres*

283 *Cleaning and Vehicle Care*

# MAINTENANCE

---

## Maintenance

### Routine Maintenance

The safety, reliability and performance of your car will depend partly on how well it is maintained. You must ensure that maintenance is carried out when required and according to the information contained in the 'Service Schedule'.

### Servicing

For Next Service <sup>\*</sup>, please refer to "Information Centre" in "Instruments and Controls" section. After each service, 'Next Service' will be reset by the local MG Authorised Repairer, which performed the maintenance.

**Note: If a service is not carried out (or the display is not reset by the local MG Authorised Repairer after service), the service display cannot provide correct information.**

### Service History

Ensure your local MG Authorised Repairer fills in the Service Records after each service.

### Brake Fluid Replacement

Replace the brake fluid according to the information contained in the "Service Schedule".

**Note: Brake fluid replacement will be an additional cost.**

### Coolant Replacement

Replace the engine coolant (mixed solution of antifreeze and water) according to the information contained in the "Service Schedule".

**Note: Coolant replacement will be an additional cost.**

### Emission Control

Your car is fitted with emission and evaporative control equipment designed to meet specific territorial and legal requirements. Incorrect engine settings may adversely affect exhaust emissions, engine performance and fuel consumption, as well as causing high temperatures, which could result in damage to the catalytic converters and engine.



## IMPORTANT

You should be aware that unauthorised replacement, modification or tampering with this equipment by an owner or motor vehicle repairer could result in the manufacturer's warranty being deemed as invalid. In addition, engine settings must not be tampered with.

### Owner Maintenance



***Any significant or sudden drop in fluid levels, or uneven tyre wear, should be reported without delay. For further information, refer to an MG Authorised Repairer.***

In addition to the routine services referred to previously, a number of simple checks must be carried out more frequently. You can carry out these checks yourself and advice is given on the pages that follow.

#### Daily Checks

- Operation of lights, horn, direction indicators, wipers, washers and warning lights.
- Operation of seat belts and brakes.

- Look for fluid deposits underneath the car that might indicate a leak.
- Check tyre appearance.

#### Weekly Check

- Engine oil level.
- Coolant level.
- Brake fluid level.
- Windscreen washer fluid level.
- Tyre pressures and condition.
- Operate air conditioning.

***Note: The engine oil level should be checked more frequently if the car is driven for prolonged periods at high speeds.***

### Special Operating Conditions

If your car is frequently used in dusty conditions, or operated in extreme climates where sub-zero or very high ambient temperatures are normal, more frequent attention may need to be paid to servicing requirements. You need to carry out special maintenance operations (refer to Warranty & Maintenance handbook or contact your MG Authorised Repairer).

# MAINTENANCE

---

## Safety in the Garage



***Cooling fans may commence operating after the engine is switched off, and continue operating for a number of minutes. Keep clear of all fans while working in the engine compartment.***

If you need to carry out maintenance, observe the following safety precautions at all times:

- Keep your hands and clothing away from drive belts and pulleys.
- If the car has been driven recently, **DO NOT TOUCH** exhaust and cooling system components until the engine has cooled.
- **DO NOT TOUCH** electrical leads or components while the engine is running, or with the ignition switch on.
- **NEVER** leave the engine running in an unventilated area - exhaust gases are poisonous and extremely dangerous.
- **DO NOT** work underneath the car with a wheel changing jack as the only means of support.

- Ensure that sparks and naked lights are far away from the engine compartment.
- Wear protective clothing and work gloves.
- Remove watches and jewelry before working in the engine compartment.
- **DO NOT** allow tools or metal parts of the car to make contact with the battery leads or terminals.

## Toxic Liquid

Fluids used in motor vehicles are poisonous and should not be consumed or brought into contact with open wounds. These include: battery acid, coolant, brake fluid, power steering fluid, fuel, engine oil and windscreen washer additives.

For your own safety, **ALWAYS** read and observe all instructions printed on labels and containers.

## Used Engine Oil

Prolonged contact with engine oil may cause serious skin disorders, including dermatitis and cancer of the skin. Wash thoroughly after contact. Used engine oil should

be disposed of correctly. Incorrect disposal can cause a threat to the environment.

# MAINTENANCE

## Bonnet

### Opening the Bonnet



**DO NOT drive when the bonnet is not closed or retained only by the safety catch.**

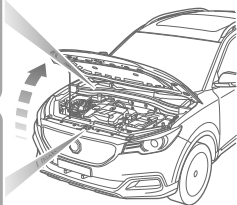
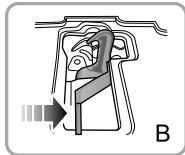
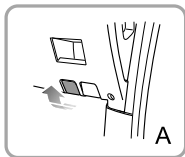

- 1 From the inside of the vehicle, pull the bonnet release handle (Figure A).
- 2 Move the safety catch release handle on the bonnet lock assembly in the direction of the arrow (Figure B) to release the bonnet safety catch.
- 3 Raise the bonnet and hold it up with the support rod firmly.

### Closing the Bonnet

Support the bonnet by one hand, release the support rod using the other hand, and place it firmly into the support rod base. Then hold the bonnet using both hands and lower it, allowing it to drop for the last 20 cm ~ 30 cm to fully close the bonnet.

By attempting to lift the front edge of the bonnet, check if the lock is fully engaged after closing the bonnet. If it is not fully engaged, you must repeat the operation.

### Bonnet Open Warning

If the bonnet is not fully engaged, when the ignition switch is in the ON/RUN position, the corresponding alarm

icon (refer to "Warning Information" in "Instruments and Controls" chapter) will be displayed in the integrated message display. If it is detected that the bonnet is not fully engaged whilst driving at a speed of greater than 3 MPH, an audible warning will sound.

**Note:** *Front wiper operation is suspended when the bonnet is open or not fully closed.*

### IMPORTANT

- For safety reasons, the bonnet should be fully latched and secure when driving. Therefore every time the bonnet is opened, you must check after closing that the bonnet is securely latched, e.g. the bonnet edge is flush with the body of the car.
- You should stop the car immediately when safety permits and close the bonnet if it is not closed fully when driving.
- Beware of injury to hands while fully closing the bonnet with a downward force.

# MAINTENANCE

---

## Engine Compartment

### I.0L Turbocharged Engine Compartment



*While working in the engine compartment, always observe the safety precautions listed under 'Safety in the Garage', refer to 'Maintenance' in 'Maintenance' section.*

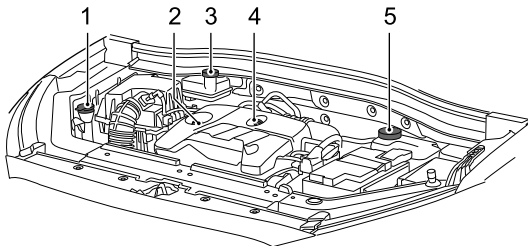

- 1 Washer fluid reservoir (blue cap)
- 2 Engine oil filler cap (black cap)
- 3 Brake fluid reservoir (yellow cap)
- 4 Engine oil dipstick (yellow)
- 5 Coolant reservoir (black cap)

## 1.5L Engine Compartment



*While working in the engine compartment, always observe the safety precautions listed under 'Safety in the Garage', refer to 'Maintenance' in 'Maintenance' section.*

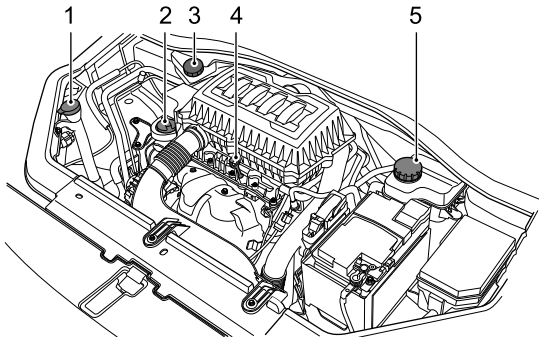

- 1 Washer fluid reservoir (blue cap)
- 2 Engine oil filler cap (black cap)
- 3 Brake fluid reservoir (yellow cap)
- 4 Engine oil dipstick (yellow)
- 5 Coolant reservoir (black cap)

# MAINTENANCE

---

## Engine

### Engine Oil

#### **ACEA Classification of Engine Oils**

European Automobile Manufacturers Association (ACEA) will classify the engine oils based on performance and quality. To ensure the best performance of the vehicle, please only use engine oils that are recommended by the manufacturer (see "Technical Data" - 'Recommended Fluids and Capacities').

If you are operating the vehicle in extreme temperature conditions please consult your MG Authorised Repairer for advice.



## Engine Oil Level Check and Refill



Driving the vehicle with the engine oil level ABOVE the upper mark, or BELOW the lower mark on the dipstick, will damage the engine. Take care to avoid spilling engine oil onto a hot engine – a fire may result!

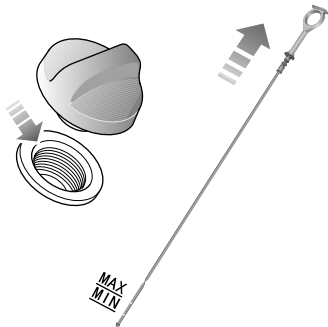

1.5 L Engine

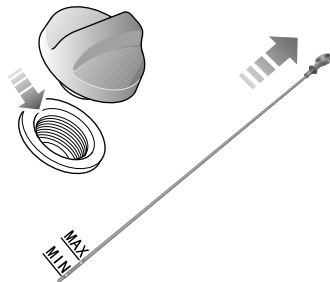

1.0 T Engine

# MAINTENANCE

---

Check the oil level weekly and top up with oil when necessary. Ideally, the oil level should be checked with the engine cold and the car resting on level ground. However, if the engine is running and already getting warm, wait for at least five minutes after switching off the ignition switch before checking the level.

- 1 Withdraw the dipstick and wipe the blade clean.
- 2 Slowly insert the oil dipstick and pull it out again to check the oil level; the oil level shall not be lower than the "MIN" mark on the oil dipstick.
- 3 Clean off any debris that may have collected around the oil filler cap area. Unscrew the oil filler cap and refill the oil to maintain the oil level between the "MAX" mark and "MIN" mark on the oil dipstick.
- 4 Wait for 5 minutes and then recheck the oil level, adding more oil if necessary – **DO NOT OVERFILL!**
- 5 Finally, ensure the dipstick and filler cap are replaced.

## Engine Oil Specification

Use the engine oil recommended and certified by the manufacturer. Refer to "Recommended Fluids and Capacities" in "Technical Data" section.

**Note: DO NOT use any oil additives.**

IMPORTANT
Check the engine oil more frequently if the vehicle is driven at high speeds for prolonged periods.

## Cooling System

### Coolant Check and Refill



**DO NOT remove the engine coolant expansion tank cap when the cooling system is hot - escaping steam or hot coolant could cause serious injury.**

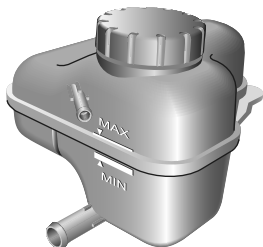

The coolant level should be checked weekly when the cooling system is cold and with the car resting on level ground.

If the coolant level is below **MIN** level, remove the pressure cap when cold and add correct coolant **MIN** to **MAX** level.

**Note: Prevent coolant coming into contact with the vehicle body when topping up. Coolant will damage paint.**

If the coolant level falls appreciably during a short period, suspect leakage or overheating and arrange for a MG Authorised Repairer to examine the car.

### Coolant Specification

Please use the coolant (mix of water and antifreeze) which is recommended and certified by the manufacturer. Please refer to 'Recommended Fluids and Capacities'.

**Note: In an emergency, top up the cooling system with clean water, but be aware of the resultant reduction in frost protection.**

## MAINTENANCE

---

**Note:** *The addition of corrosion inhibitors or other additives to the cooling system of this car may severely disrupt the efficiency of the system and cause engine damage. For cooling system issues please consult an MG Authorised Repairer.*



*Antifreeze is poisonous and can be fatal if swallowed - keep containers sealed and out of the reach of children. If accidental contact is suspected, seek medical attention immediately.*



*Prevent antifreeze coming into contact with the skin or eyes. If this occurs, rinse immediately with plenty of water. If eyes are still red, painful or uncomfortable, seek medical attention immediately.*

## Brake

### Brake Pads



**DO NOT rest your foot on the brake pedal while driving; this may overheat the brakes, reduce their efficiency and cause excessive wear.**

For the first 900 miles (1500 km), you should avoid situations where heavy braking is required.

Remember that regular servicing is vital to ensure that all the brake components are examined for wear at the correct intervals, and replaced when required to ensure long term safety and optimum performance during the interval prescribed in Warranty and Maintenance Manual.

The car needs to run in for 500 miles (800 km) after the brake pad or disc is replaced.

### Brake Fluid Check and Top Up



**Brake fluid is highly toxic, keep containers sealed and out of the reach of children. If accidental contact of brake fluid is suspected, seek medical attention immediately.**



**Prevent brake fluid coming into contact with the skin or eyes. If this occurs, rinse immediately with plenty of water. If eyes are still red, painful or uncomfortable, seek medical attention immediately.**

The brake fluid level should be checked weekly when the system is cold and with the car on level ground.

The fluid level can be seen through the reservoir neck and should be maintained as close to the "MAX" mark as possible. Do not allow the level to drop below the "MIN" mark.

**Note: Brake fluid will damage painted surfaces. If you accidentally spill the brake fluid on the painted surface, soak up any spillage with an absorbent cloth**

# MAINTENANCE

---

*immediately and wash the area with water or car shampoo.*

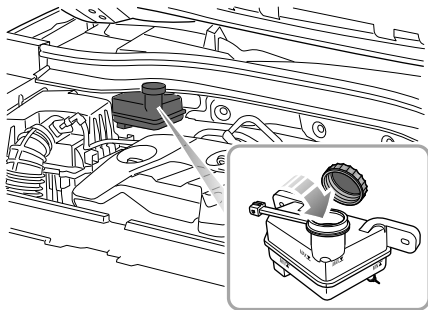

## IMPORTANT

Replace brake fluid regularly according to the manufacturer's service schedule.

## Brake Fluid Specification

Use the brake fluid recommended and approved by the manufacturer. Refer to "Recommended Fluids and Capacities" in the "Technical Data" section.

## Battery

### Battery Maintenance



**DO NOT** leave electric components switched on when the engine is not running, the battery may become flat and you will not be able to start the engine.

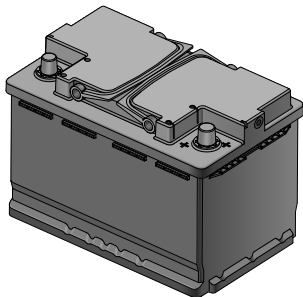

You can see the battery when you open the engine compartment. The battery is maintenance-free type, therefore there is no need to refill fluid.

**Note:** *If the vehicle is stored for more than 1 month, remove the negative terminal from the battery. Make sure that the ignition switch has been turned off before connecting or disconnecting the negative terminal. When connecting the negative terminal again, the vehicle must be left in a locked state for 4 hours to re-calibrate the battery condition. Failure to adhere to this will inhibit the stop/start functionality.*

### Battery Replacement



**The battery contains sulphuric acid, which is corrosive.**

The battery contains sulphuric acid, which is corrosive. Please go to a local MG Authorised Repairer to remove and install the battery.

**Note:** *Only fit a replacement battery of the same type and specification as the original to maintain the correct vehicle functionality.*

## MAINTENANCE

---



The battery must be disposed of using an approved method, used batteries can be harmful to the environment. It should be recycled by a professional company. Please consult an MG Authorised Repairer more details.



## Washers

### Windscreen Washer Check and Top Up



*When filling the washer fluid, DO NOT let the washer fluid spill on parts around the engine or on the paint surface of vehicle body. In case the washer fluid is spilled on hands or other parts of the body, please immediately wash with clean water.*

Check the washer fluid level every week. When the level of washer fluid is low, please top up the washer fluid as instructed.

**Note:** *DO NOT use anti-freeze or vinegar/water solution in the washer reservoir - anti-freeze will damage paintwork while vinegar will damage the washer pump.*

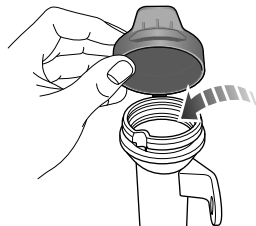

#### IMPORTANT

- Use the washer fluid recommended and certified by the manufacturer. Misuse of washer fluid in winter may cause damage to the washer pump due to freezing.
- Using the washers when there is no washer fluid may cause damage to the washer pump.
- Operating the wipers when the windshields are dry and there is no washer fluid may cause damage to the windshields and wipers. Please spray the washer fluid and start the wipers when there is adequate washer fluid.

# MAINTENANCE

---

## **Washer Nozzles**

Operate the washers periodically to check that the nozzles are clear and properly directed.

If the nozzle is obstructed, insert a needle or thin metal wire into the hole to remove the obstruction.

## **Washer Fluid Specification**

Use the washer fluid recommended and certified by the manufacturer. Refer to 'Recommended Fluids and Capacities'.

## Wipers

### Wiper Blades

#### IMPORTANT

- Grease, silicon and petrol based products impair the blade's wiping capability. Wash the wiper blades in warm soapy water and periodically check their condition.
- Clean the windscreen frequently, DO NOT use wipers to remove stubborn or ingrained dirt, it will reduce their effect and their life span.
- If signs of hardness or cracking in the rubber are found, or if the wipers leave streaks or unwiped areas on the screen, then the wiper blades should be replaced.
- Clean the windscreen regularly with an approved glass cleaner and ensure the screen is thoroughly cleaned before fitting replacement wiper blades.
- Only fit replacement wiper blades that are identical to the original specification.
- Clean ice and snow from around wipers and ensure they are not frozen or otherwise sticking to the windscreen before attempting to operate them.

# MAINTENANCE

---

## Replacing Front Wiper Blades

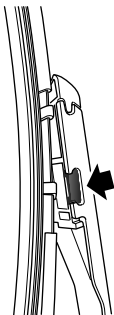

- 1 With the bonnet closed and the ignition switch in the OFF position, within 20 seconds of switching the ignition OFF press the wiper switch down and release, the wipers will enter the 'service position' and stop on the windscreen.
- 2 Lift the wiper arm away from the windscreen.
- 3 Press the retaining clips at both sides (as shown in the figure), whilst pulling the wiper blade outward, to remove the wiper blade from the wiper arm and discard.
- 4 Position the fitting of the new wiper blade into the slot of the wiper arm.
- 5 Push the wiper blade towards the wiper arm until the it is located embedded with a click been heard.
- 6 Place the wiper assembly back on the windscreen.
- 7 Press down the wiper stalk switch again and release, or turn on the ignition switch, the wiper will exit the service mode and automatically return to its original position.

### Replacing Rear Wiper Blades

4 Place the wiper assembly back on the rear window.

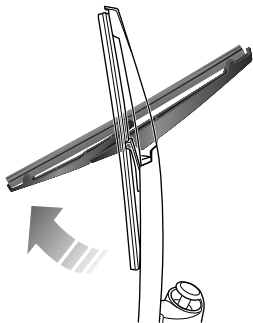

- 1 Lift the wiper arm away from the rear window.
- 2 Rotate the wiper blade as shown in the figure, to remove it from the wiper arm and discard.
- 3 Position the fitting of the new wiper blade into the slot of the wiper arm. Ensure the wiper blade is properly secured on the wiper arm.

# MAINTENANCE

---

## Tyres

### Overview

- Take extra care when using new tyres for the first 300 miles (500 kilometers).
- Avoid excessive cornering at speed.
- Slow down when passing through road shoulder or a similar section, and allow the wheels to go through the shoulder at the right angle as far as possible.
- Regularly check the damage of tyres (stabs, scratches, cracks and pits) and remove any foreign objects from the tread.
- Prevent the tyre from contacting oil, grease and fuel.
- Ensure valve caps are always fitted.
- If the tyre is to be removed always mark the tyre/wheel orientation to ensure correct reinstallation.
- The wheels or tyres that have been disassembled should be kept in a cool, dry and light-free place.

### New Tyres

New tyres may not have the best adhesive ability at the beginning. Therefore, driving your vehicle at moderate

speed and in a prudent way at the first 300 miles (500 kilometers), which is also beneficial to the service life of the tyres.

The damage of tyre or rim may happen unnoticed. If abnormal vibration or handling is experienced, that means the tyre or rim may have been damaged. Please slow down and park your vehicle in absolute safety, then check the tyre and rim. If you can't see the damage from the outside, you should continue to drive with low speed and go to the nearest MG Authorised Repairer for inspection.

### Directional Tyres

Directional tyres are marked with 'direction of rotation' (DOR). To maintain handling characteristics, tyre performance, low road noise and extend tyre life, tyres must always be fitted with indication arrow showing the correct 'DOR'.

### Tyre Life

Correct tyre pressure and moderate driving style can extend tyre life.

Recommendations:

- If the vehicle is to be stored for a lengthy time, please move your vehicle at least once in two weeks to 'rotate the tyres'.
- Check the pressure of tyres regularly when they are cold.
- Avoid cornering at excessive speed.
- Regularly check tyres for abnormal wear patterns.

These following factors may affect the tyre life.

## Tyre Pressure

Incorrect pressure will cause the abnormal wear of the tyre, greatly shorten the service life, and have an adverse effect on the driving characteristics of the vehicle. Tyre pressure should be checked at least once a month, and once prior to each long-distance journey.

## Driving Style

Excessively harsh acceleration and braking ( you may hear a piercing noise) or driving at high speed whilst cornering will increase the wear of tyre.

## Wheel Balance

The working balance of auto-wheels is well tested before a new vehicle comes out of the factory. But the wheels may be out of balance due to many factors.

If wheels are out of balance, shaking or vibration of the steering mechanism may occur and the tyres may be excessively worn. It is important to rectify this quickly. Each wheel should be rebalanced after installing a new tyre or having the tyre repair.

## Wheel Alignment

Incorrect wheel alignment can cause excessive tyre wear and affect vehicle safety. If the tyres show signs of abnormal wear, seek advice from an MG Authorised Repairer.

## Caring for Your Tyres



**DEFECTIVE TYRES ARE DANGEROUS!**  
**DO NOT drive if any tyre is damaged, is excessively worn, or is inflated to an incorrect pressure.**

# MAINTENANCE

---

Always drive with consideration for the condition of the tyres, and regularly inspect the tread and side walls for any sign of distortion (bulges), cuts or wear.

**Note: If possible, protect tyres from contamination by oil, grease and fuel.**

## Tyre Pressure



**Before a long distance journey, the tyre pressure must be checked.**

Check the pressure (including the spare wheel) at least once a month, when the tyres are cold.

If it is necessary to check the tyre pressure when they are warm, you should expect the pressure to have increased by 0.3 to 0.4 bar (4.35 to 5.8 psi). In this circumstance, NEVER let air out of the tyres in order to match the recommended pressure (cold).

## Valves

Keep the valve caps screwed down firmly - they prevent dirt from entering the valve. Check the valve for leaks (listen for a tell-tale hissing) when you check the tyre pressure.

## Punctured Tyres

If a sharp object penetrates the tyre and remains in it, the tyre may not leak. If you are aware of this occurring, reduce speed immediately and drive with caution until the spare wheel can be fitted, or repairs undertaken.

**Note: If the sidewall of the tyre is damaged or distorted, replace the tyre immediately, do not attempt a repair.**



## Tyre Wear Indicators

At the bottom of the original tyre, there is a 1.6 millimeter high wear mark perpendicular to the wheel rolling direction. These indicators moulded into the tread pattern at several points around the circumference. A mark on the side of a tyre, such as the upper case letter TWI or the triangle, indicating the position of the wear mark.

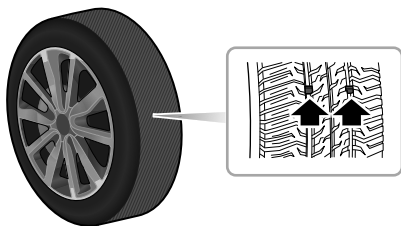

When the tread has worn down to 1.6 millimeter, the indicators will come to the surface of the tread pattern,

producing the effect of a continuous band of rubber across the width of the tyre.

### IMPORTANT

A tyre **MUST** be replaced as soon as a wear indicator becomes visible.

## Replacement Tyres



*It is recommended to install the tyres consistent with the original specifications. DO NOT replace the tyres with tyres of any other type. Alternative tyres, of a different specification, may adversely affect the vehicle's driving characteristics and safety. In order to make your driving and safety better guarantee, it is suggested that you consult an MG Authorised Repairer.*

Always have replacement wheels and tyres balanced before use.

# MAINTENANCE

---

## Wheel Fitment Rotation

It is not recommended that you swap wheels from side to side or front to rear in order to equalise tyre wear. Your vehicle is fitted with Tyre Pressure Monitoring System which means that each wheel is programmed to the relative position.

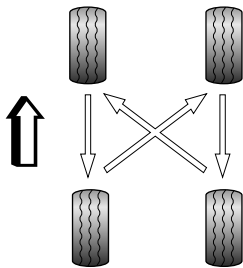

If you do wish to swap wheels and tyres around on the vehicle please consult an MG Authorised Repairer as extra coding will be required.

## Snow Chains

Unsuitable snow chains could damage the tyres, wheels, suspension, brakes or bodywork of your car.

Please pay attention to the following requirements in the usage:

- The tyre/snow chains can only be fitted on the front wheels;
- The thickness of tyre/snow chains shall not exceed 12 mm;
- Please always observe the installation and tension instructions for the tyre/snow chains, as well as the speed limitations of different roads;
- DO NOT drive faster than 30 mph (50 km/h) ;
- To avoid the tyre damage and excessive wear of the tyre/snow chains, the tyre/snow chains must be removed while driving on the road without snow.

**Note: If you drive on the snowy and icy roads, it is recommended to use winter tyres. Consult an MG Authorised Repairer for details.**

## Cleaning and Vehicle Care



**Observe all safety precautions on cleaning products; do not drink fluids and keep them away from the eyes.**

## External Car

### Washing Your Car



**Some high pressure cleaning systems will penetrate door, window and sunroof seals, and damage lock mechanisms. DO NOT aim water jets directly at components that might be easily damaged.**



**Do not clean the engine compartment with high pressure water since it may damage the electrical system of the vehicle.**

In order to preserve the paint finish on your car, please observe the following care points:

- DO NOT use hot water to wash the car.
- DO NOT use detergents or washing up liquid.
- In hot weather, DO NOT wash the car in direct sunlight.

- When using a hose, DO NOT aim the water directly at window, door or sunroof seals, or through wheel apertures onto the brake components.

If the car is particularly dirty, use a hose to flush grime and grit from the bodywork, prior to washing. Then, wash the car using cold or lukewarm water containing a good quality wash and wax shampoo. Always use plenty of water to ensure that grit is flushed from the surface and not ground into the paintwork. After washing, rinse the bodywork with clean water and dry off with a chamois leather.

### Cleaning the underside

**Note: DO NOT use a high pressure hose to clean the engine compartment – damage to the car's electronic systems may occur.**

From time to time, but particularly during winter months when salt has been used on the roads, use a hose to wash the underside of the car. Flush away accumulations of mud and thoroughly clean those areas where debris can easily collect (wheel arches and panel seams, for example).

# MAINTENANCE

---

## IMPORTANT

- Avoid cleaning the vehicle in direct sunlight.
- When cleaning the vehicle in winter avoid spraying water directly onto door locks and panel gaps due to risk of icing.
- Do not use rough sponges or cloth to clean the car, this will damage the paintwork finish.
- When cleaning the headlamps do not use a dry cloth or sponge, use only warm soapy water.

### ***Cleaning with a High Pressure Cleaner***

**Note:** *Always read the manufacturers operating instructions.*

When using high pressure washers, always ensure there is adequate distance between the spray nozzle and any soft materials, decals or rubber seals.

## IMPORTANT

- Please pay attention to the operating instructions of high pressure cleaner.
- Soft parts on the vehicle should be kept in a large enough distance from the high pressure cleaner.

### **Removing tar spots**

Use white spirit to remove tar spots and stubborn grease stains from the paintwork. Then wash the area immediately with soapy water to remove all traces of the spirit.

### **Body Protection**

After washing, examine the paintwork for damage. If the damage has revealed bare metal, use a colored primer first, then apply the correct colour base coat and finish off with a lacquer pencil, if appropriate. Carry out this treatment after washing but before polishing or waxing. More extensive damage to paint or bodywork must be repaired in accordance with the manufacturer's recommendations. Failure to do this will invalidate the Anti-Corrosion Warranty. If in doubt, ask your MG Authorised Repairer.

## Polishing the Paintwork



**DO NOT use car polish containing coarse abrasives – these will remove the paint film and damage the gloss finish.**

Occasionally treat the paint surface with an approved polish containing the following properties:

- Very mild abrasives to remove surface contamination without removing or damaging the paint.
- Filling compounds that will fill scratches and reduce their visibility.
- Wax to provide a protective coating between the paint and the elements.

**Note: If possible, avoid applying polish or wax products to window glass and rubber seals.**

## Wiper Blades

Wash in warm soapy water. DO NOT use spirit or petrol based cleaners.

## Windows and Mirrors

Regularly clean all windows, inside and out, using an approved glass cleaner.

**Windscreen:**In particular, clean the outside of the screen with glass cleaner after washing the car with wash and wax products, and before fitting new wiper blades.

**Rear screen:**Clean the inside with a soft cloth, using a side to side motion to avoid damaging the heating elements.

**Note: DO NOT scrape or use abrasive cleaners on the inside of the rear screen – this will damage the heating elements.**

**Mirrors:**Wash with soapy water. Use a plastic scraper to remove ice. DO NOT use abrasive cleaning compounds or metal scraper.

## Plastic Components

Any plastic components should be cleaned using conventional cleaning methods and not be treated with abrasive materials.

# MAINTENANCE

---

## Paint Damage

Any paint damage or stonechips should be treated with suitable paint/lacquer materials immediately to avoid invalidating the Anti Corrosion Warranty.

## Weather Strips and Rubber Seals

Any weather strips or rubber aperture seals should be treated with suitable materials (silica gel) if they are cleaned using strong detergents, this should avoid any sticking and maintain the service life of the seal.

## Wheels



***When cleaning the wheels any materials or water that contact the brake disc directly may effect braking efficiency.***

In order to ensure the wheels are kept in optimum condition they should be cleaned regularly.

Only use a recommended non-acidic propriety wheel cleaner. Always read the instructions on the product.

## Cleaning the Interior

### Plastic materials

Clean plastic-faced materials with diluted upholstery cleaner, then wipe with a damp cloth.

***Note: DO NOT polish dashboard components – these should remain non-reflective.***

### Carpet and fabrics

Clean with diluted upholstery cleaner - test a concealed area first.

### Leather

Clean leather trim with warm water and a non-detergent soap. Dry and polish the leather with a dry, clean, lint-free cloth.

***Note: DO NOT use petrol, detergents, furniture creams or polishes as cleaning agents.***

### Instrument Pack, Audio and Navigation Display

Clean with a dry cloth only. DO NOT use cleaning fluids or sprays.

### Airbag Module Covers



**DO NOT allow these areas to be flooded with liquid and DO NOT use petrol, detergent, furniture cream or polishes.**

To protect damage to the airbag SRS, the following areas should be cleaned sparingly with a damp cloth and upholstery cleaner ONLY:

- Steering wheel centre pad.
- Area of dashboard containing the passenger airbag.
- Area of roof lining and front pillar finishers which enclose the side head impact protection modules.

### Seat Belts



**DO NOT use bleaches, dyes or cleaning solvents on seat belts.**

Extend the belts, then use warm water and a non-detergent soap to clean. Allow the belts to dry naturally; DO NOT retract them or use the car until they are completely dry.





## **Technical Data**

---

*290 Technical Data Dimensions*

*291 Weights*

*294 Major Parameters of Engine*

*296 Recommended Fluids and  
Capacities*

*298 Wheel Alignment (Unladen  
Condition)*

*298 Wheels and Tyres*

*299 Tyre Pressure (Cold)*

# TECHNICAL DATA

## Technical Data Dimensions

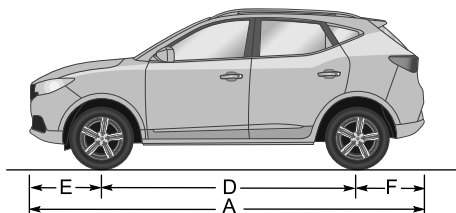
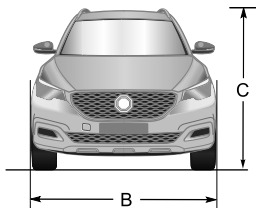

Item, Units	Parameters
Overall length A, mm	4314
Overall width B, mm	1809
Overall height C (unladen, excluding luggage rack), mm	1610 (R15 tyre)/ 1620 (R17 tyre)
Wheelbase D , mm	2585
Front Overhang E , mm	913

Item, Units	Parameters
Rear Overhang F , mm	816
Front Wheel Track , mm	1529
Rear Wheel Track , mm	1536
Minimum Turning Diameter , m	11.15
Fuel Tank Capacity , L	48

**Weights**

Item, Units	Parameters	
	1.5L-MT	1.0T-AT
Person in cab, person	5	
Unladen vehicle weight (kerb), kg	1204	1239
Gross vehicle weight, kg	1695	1730
Gross train weight, kg	2195	2230

**Towing Weights**

Item, Units	Parameters
Towing limit unbraked, kg	500
Towing limit braked, kg	500
Towing hitch load, kg	50

# TECHNICAL DATA

## Towing Bar Dimensions

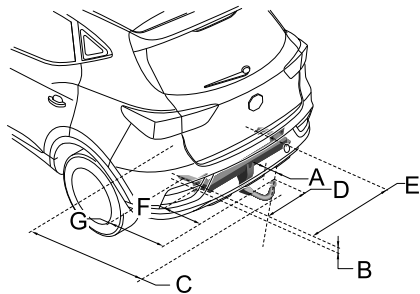

Item	Dimension Description, Units	Parameters
A	Bumper to centre of tow ball, mm	73
B	Attachment point to centre the tow ball, mm	38
C	Wheel centre to centre of tow ball, mm	893
D	Centre of tow ball to side member, mm	469

## TECHNICAL DATA

Item	Dimension Description, Units	Parameters
E	Distance between side members, mm	938
F	Centre of tow ball to centre of first attachment point, mm	302
G	Centre of tow ball to centre of second attachment point, mm	438

## TECHNICAL DATA

---

### Major Parameters of Engine

Vehicle	Parameter
	I.0T-AT
Bore × Stroke, mm × mm	74×77.4
Capacity, Litres	0.999
Compression ratio	10.5 : 1
Maximum torque, Nm	160
Engine speed to develop maximum torque, rev/min	1800–4700
Idle speed, rev/min	900
Fuel type, RON	Unleaded 95 RON to EN228 SPEC

## TECHNICAL DATA

Vehicle	Parameter
	1.5L-MT
Bore × Stroke, mm × mm	75×84.8
Capacity, Litres	1.498
Compression ratio	11.5:1
Maximum torque, Nm	141
Engine speed to develop maximum torque, rev/min	4500
Idle speed, rev/min	680
Fuel type, RON	Unleaded 95 RON to EN228 SPEC

## TECHNICAL DATA

---

### Recommended Fluids and Capacities

Name	Grade	Capacity
		1.5L-MT
Engine oil (after-sales replacement), L	A5/B5 5W-30 or C5 0W-20	4.1
Engine coolant, L	Glycol (OAT)	5.4
Manual transmission oil, L	MTF94	1.8
Brake fluid, L	DOT 4	0.85
Washer fluid, L	ZY-VIII	4.0
Air conditioning refrigerant, g	R1234yf	520±25
Air conditioning compressor oil, ml	SP-A2	140±10



## TECHNICAL DATA

Name	Grade	Capacity
		I.0T-AT
Engine oil (after-sales replacement), L	C3 5W-30 or C5 0W-20	4.0
Engine coolant, L	Glycol (OAT)	5.8
Automatic transmission fluid, L	AW-I	6.2
Brake fluid, L	DOT 4	0.85
Washer fluid, L	ZY-VIII	4.0
Air conditioning refrigerant, g	R1234yf	520±25
Air conditioning compressor oil, ml	SP-A2	80±10

## TECHNICAL DATA

### Wheel Alignment (Unladen Condition)

Item		Parameter
Front	Camber angle	$-0^{\circ}36\phi \pm 45\phi$
	Castor angle	$4^{\circ}02\phi \pm 45\phi$
	Toe-in(Total)	$0^{\circ}8\phi \pm 15\phi$
	King pin inclination	$12^{\circ}05\phi \pm 45\phi$
Rear	Camber angle	$-1^{\circ}15\phi \pm 45\phi$
	Toe-in(Total)	$0^{\circ}25\phi \pm 20\phi$

### Wheels and Tyres

Wheel size	7.0J×17	6.0J×15
Tyre size	215/50 R17 91V	195/65 R15 91H

### Spare Tyre \*

Wheel Rim Specification	4.0J×16
Spare Tyre Specification	T125/90 R16

**Note:** It is recommended to fit tyres having the same specification to the original tyres.

**Note:** Alternative tyres, of a different specification, or unqualified tyres may adversely affect the car's driving characteristics and safety. For better guarantee of your safety, we recommend you consult the MG Authorised Repairer.

### Tyre Pressure (Cold)

Wheels	Unladen
Front Wheels	230kPa/2.3bar/33psi
Rear Wheels	200kPa/2.0bar/29psi
Spare Tyre	420kPa/4.2bar/60psi



## **Appendix**

---

302 *Removable Tow Bar*

# APPENDIX

---

## Removable Tow Bar

### Tow Bar Operating Instructions

#### Safety:

Operation of the detachable tow bar should only be performed by hand, never use hand tools to operate the locking mechanism.

If the trailer is fitted with a security cable or brake cable it must be attached to the dedicated connection hole in the fixed part of the tow bar.

When a stabiliser coupling is installed on the trailer never use grease on the tow ball.

Always remove the detachable tow ball when not in use if it obscures the registration plate.

#### Preparation:

Remove tow ball cover.

Ensure the tow ball is clean and free from dirt and debris.

Ensure the tow ball is in the 'spring position' (see picture 3.1).

The tow ball is in the spring position if:

- The operating handle is pushed in completely and no colour indication is shown inside the indication area of the operating handle.
- The slider is pulled fully towards the tow ball (shown in picture 3.1).
- It is not possible to lock the system with the supplied locking keys (see picture 5.2).

The tow ball is NOT in the spring position if:

- The operating handle is popped out and shows a red field in the indication area of the operating handle (see picture 3.1)
- The slider is pushed out towards the tow ball (the part is indicated by in picture 3.1).
- It is possible to lock the system with the supplied keys (see picture 5.2).

To place the tow ball in the spring position:

- Unlock the tow ball (see picture 6.1)
- Push the operating handle inwards, rotate in a clockwise direction (whilst pushing inwards) until the handle remains in position (see picture 3.2). If unsure repeat operation.

**Note:** If a tow ball cannot be tensioned into the spring position it cannot and **MUST NOT** be used.

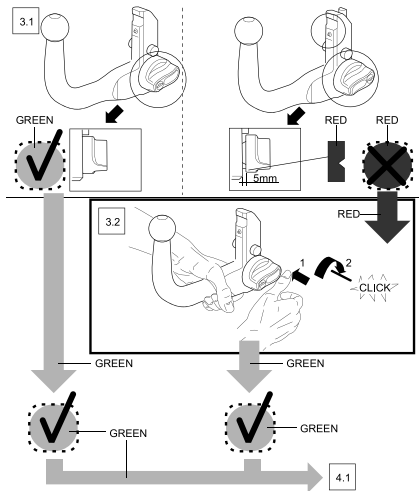

### Attachment:

Before attaching the tow ball to the car please remove the cover from the housing (see picture 4.1).

- Insert tow ball (that must be in the spring position) fully into the housing.
- Hold the tow ball in position, keeping your hands away from the operating handle, use a slight force to pull at the tow ball as shown in picture 4.3.
- The unlocking pin will trigger the locking mechanism and the locking process will automatically take place.
- Always check the tow ball is correctly installed, this can be recognised by:
  - The operating handle pops out and an approximate gap of 5 millimeters will be visible between the tow ball and the operating handle (see picture 5.1).
  - A green field will be visible in the indication area of the operating handle (see picture 5.1).
- The tow ball can be locked using the supplied keys (see picture 5.2). This can only be done when the handle has popped out completely, after this the handle can no longer be pushed in and the tow ball cannot be released (remember to remove the keys).

## APPENDIX

---

- Check the tow ball for security – no play should be evident.

The tow ball is now ready for use.

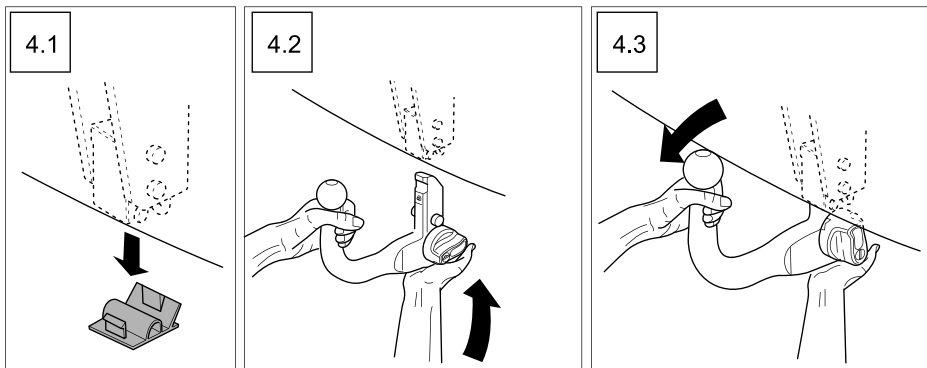



### Care Points

- Always check the tow ball for correct mounting every time prior to use.
- Never attempt to attach/detach a tow ball whilst trailer/accessory attached.
- Always keep the tow ball clean and free from debris, do not clean with high pressure washer.
- Never use a tow ball that has signs of damage, excessive wear or modification.
- Never use a tow ball that has been installed by any other method than 'hand pressure'.

### Removal

Always disconnect the trailer/accessory and safety cable prior to tow ball removal.

- Unlock the detachable tow ball by turning the locking key clockwise using your thumb and forefinger (see picture 6.1).
- Hold the tow ball with your left hand, push the operating handle fully inwards and turn clockwise until the operating handle remains in position (see picture 6.3).

- The tow ball can now be removed from the housing in a downward motion (see picture 6.4). **WARNING**, this item is heavy, do not allow it to drop.
- Refit the plastic cover into the housing (see picture 6.5).

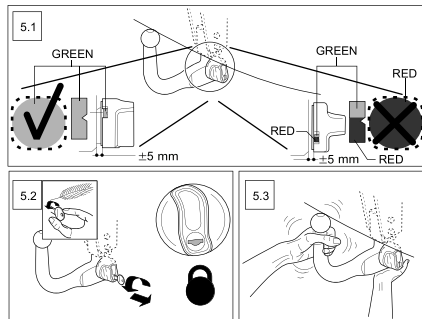

# APPENDIX

---

